

Das Instrument.

 **BMT**
Medizintechnik GmbH
BMTsurgical.com



Chirurgia Veterinaria
Cirugía Veterinaria
Chirurgie Vétérinaire

Veterinärchirurgie
Veterinary Surgery



Our Mission

Establish a global presence as a leading designer and manufacturer of high quality handheld surgical instruments in the dental and medical surgical fields. Our goal will be achieved through the offering of excellent products and services; and by our commitment to exceed customer expectations.

About Us

BMT Medizintechnik GmbH (located in Tuttlingen, Germany) designs, manufactures and markets a complete product portfolio of over 10,000 surgical instruments to the dental and medical markets. For decades, our brand has gained recognition in the European marketplace as a high quality premier brand, and, in recent years, has made its mark into the North American marketplace where it continues to be recognized for its exceptional quality.



What makes us different? Outstanding quality!

BMT manufactures surgical instruments from martensitic stainless steels (AISI 1 421, 440, 440C2) which is the highest quality stainless steel available. Our brand is built on outstanding product quality, service and an unsurpassed warranty of 5 years against manufacturing defects!

Industry Participation

As a leading global provider of surgical instruments, BMT has major distributors located throughout Europe, the Americas, the Middle East and Asia. BMT maintains its leadership in innovation by working closely with its distributors and surgical practitioners to develop new products. BMT is also in the forefront of product education by offering and participating in seminars and other educational events on proper instrument selection, usage and care. BMT continues to establish itself as a premier surgical instrument company by attending and supporting leading conferences throughout the world.

Product and Quality Certifications

BMT products are registered and comply with European Conformity (CE), U.S. Food and Drug Administration (FDA), Health Canada, and Korean Food and Drug Administration (KFDA).

BMT Germany | Headquarters
Moltkestraße 37-39, D-78532
Tuttlingen, Deutschland
Office: + 49 7461 96 67 50
Fax: + 49 7461 96 67 52

 **BMT** Medizintechnik GmbH

info@bmtsurgical.com

BMTsurgical.com

BMT North America
+ 1 888-333-3044 (Toll free)
BMT Latin America
+ 1 514-384-3293



Préparation Schere
 Scissor dissection
 Forbice per dissezione
 Tijeras para disección
 Ciseaux de dissection

Cockpitteile und außen
 Cutting internal and external
 Taglio interno ed esterno
 Acabados interiores y exteriores
 Garnitures intérieures et extérieures

Gezant
 Serrated
 Dentellate
 Dentadas
 Denteles

Kurzen Ende
 Short end
 Punta corta
 Punta corta
 Pointe courte

Fein
 Delicate
 Fine
 Finas
 Fins

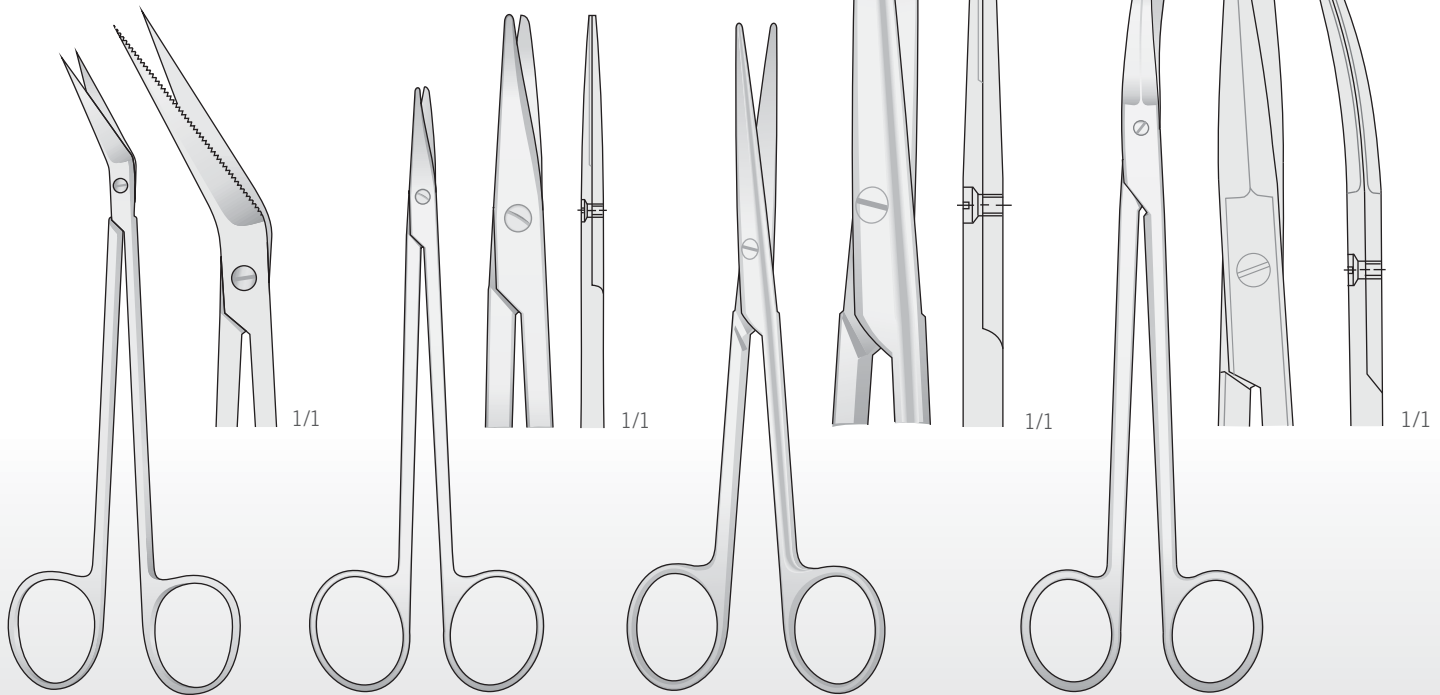

LOCKLIN
LK-4
 160 mm

METZENBAUM
FM-12
 150 mm

LEXER
FM-180
 165 mm

FG-10
 185 mm



General Surgery
Allgemeine Chirurgie
Chirurgie générale
Cirugía General
Chirurgia Generale

Fein - Delicate
Fine - Finas
Fins

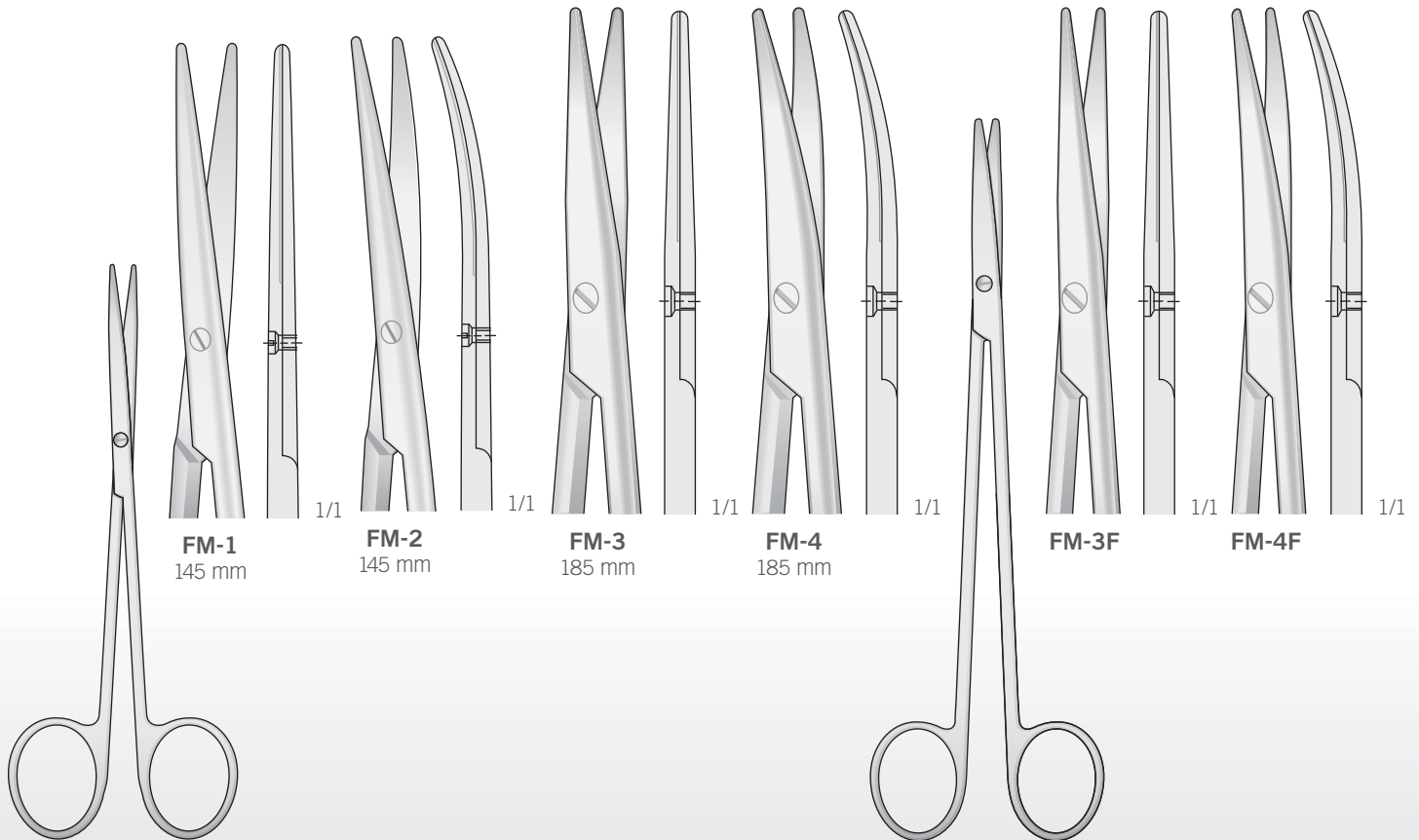

METZENBAUM
FM-1/FM-2
145 mm

METZENBAUM
FM-3F/FM-4F
185 mm

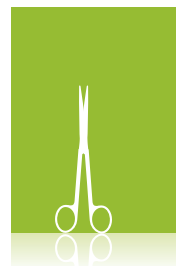

Scheren für Verbände
 Scissors for bandages
 Forbici per bende
 Tijeras para vendajes
 Ciseaux pour bandages

Schere zu entfernen Nähte
 Scissors to remove sutures
 Forbici per rimuovere suture
 Tijeras para quitar las suturas
 Des ciseaux pour enlever les sutures

Pinzette zum Entfernen von Drähten
 Tweezers for removing wires
 Pinza per rimozione punti metallici
 Pinzas para quitar cables
 Pince à épiler pour enlever les fils

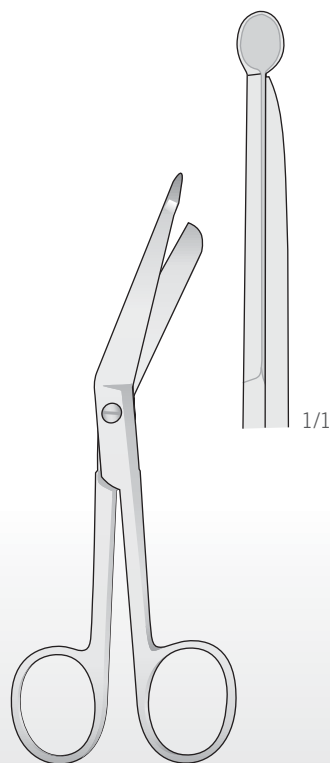

LISTER
FG-31 145 mm
FG-32 180 mm

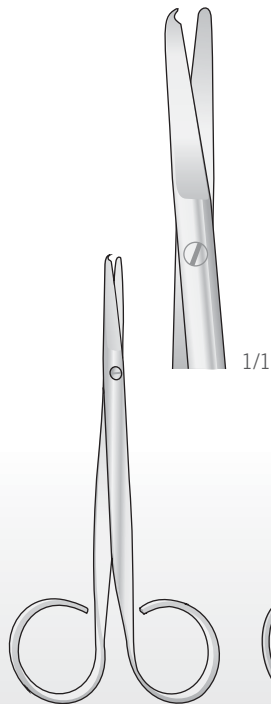

SPENCER
SC-1
 110 mm

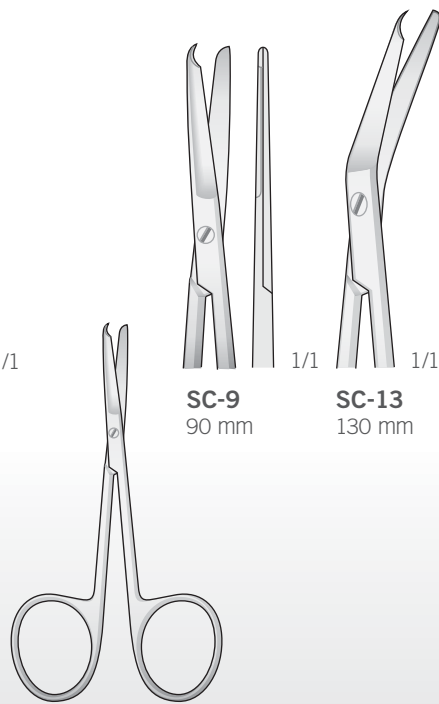

SPENCER
SC-9/SC-13

SC-9
 90 mm

SC-13
 130 mm

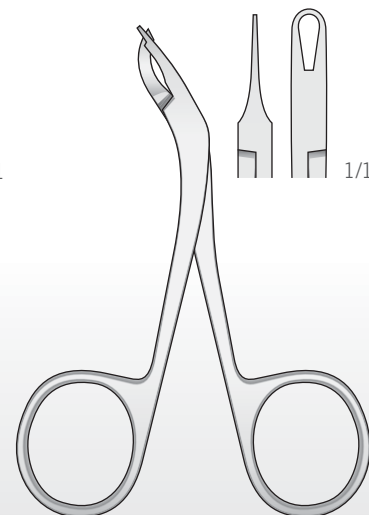

BF-64
 115 mm



General Surgery
 Allgemeine Chirurgie
 Chirurgie générale
 Cirugía General
 Chirurgia Generale

TC

Mit Hartmetalleinsätzen
 Tungsten-carbide scissors
 Forbici con lame al carburo di tungsteno
 Tijeras con placas de carburo de tungsteno
 Siceaux vec plaquettes en carbure de tungstène

Mit einer Schneide gezahnt
 With one blade serrated
 Con una lama dentellata
 Con una hoja dentada
 Avec une lame dentèle

Spitz
 Sharp
 Acuta
 Aguda
 Pointu

TC

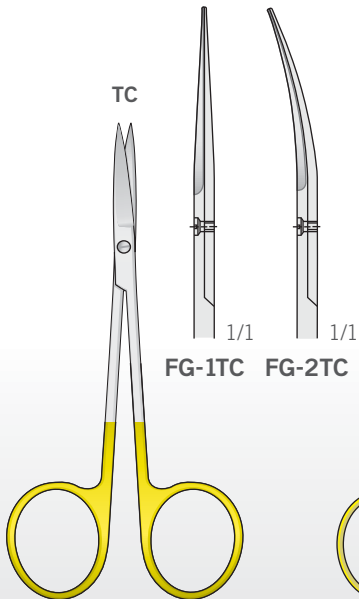

FG-1TC FG-2TC

IRIS
FG-1TC/FG2-TC
 115 mm

TC

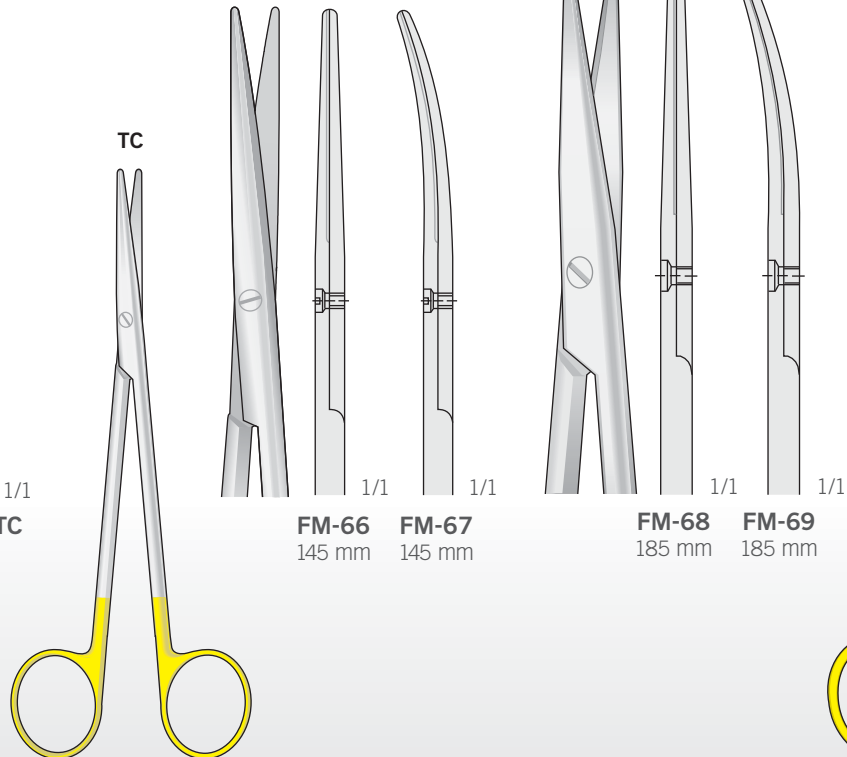

FM-66 FM-67 FM-68 FM-69
 145 mm 145 mm 185 mm 185 mm

METZENBAUM
FM-66/FM-69
 145 mm

TC

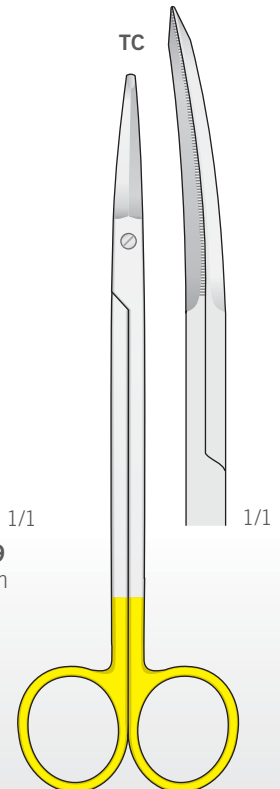

FACE-LIFT
FM-343
 180 mm

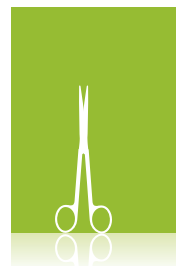

TC

Mit Hartmetalleinsätzen - Mit einer Schneide gezahnt
 Tungsten-carbide scissors - With one blade serrated
 Forbici con lame al carburo di tungsteno - Con una lama dentellata
 Tijeras con placas de carburo de tungsteno - Con una hoja dentada
 Siseaux vec plaquettes en carbure de tungstène - Avec une lame dentée

Super Cut - TC

Mit Hartmetalleinsätzen - Mit einer Schneide gezahnt
 Tungsten-carbide scissors - With one blade serrated
 Forbici con lame al carburo di tungsteno - Con una lama zigrinata
 Tijeras con placas de carburo de tungsteno - Con una hoja dentada
 Siseaux vec plaquettes en carbure de tungstène - Avec une lame dentée

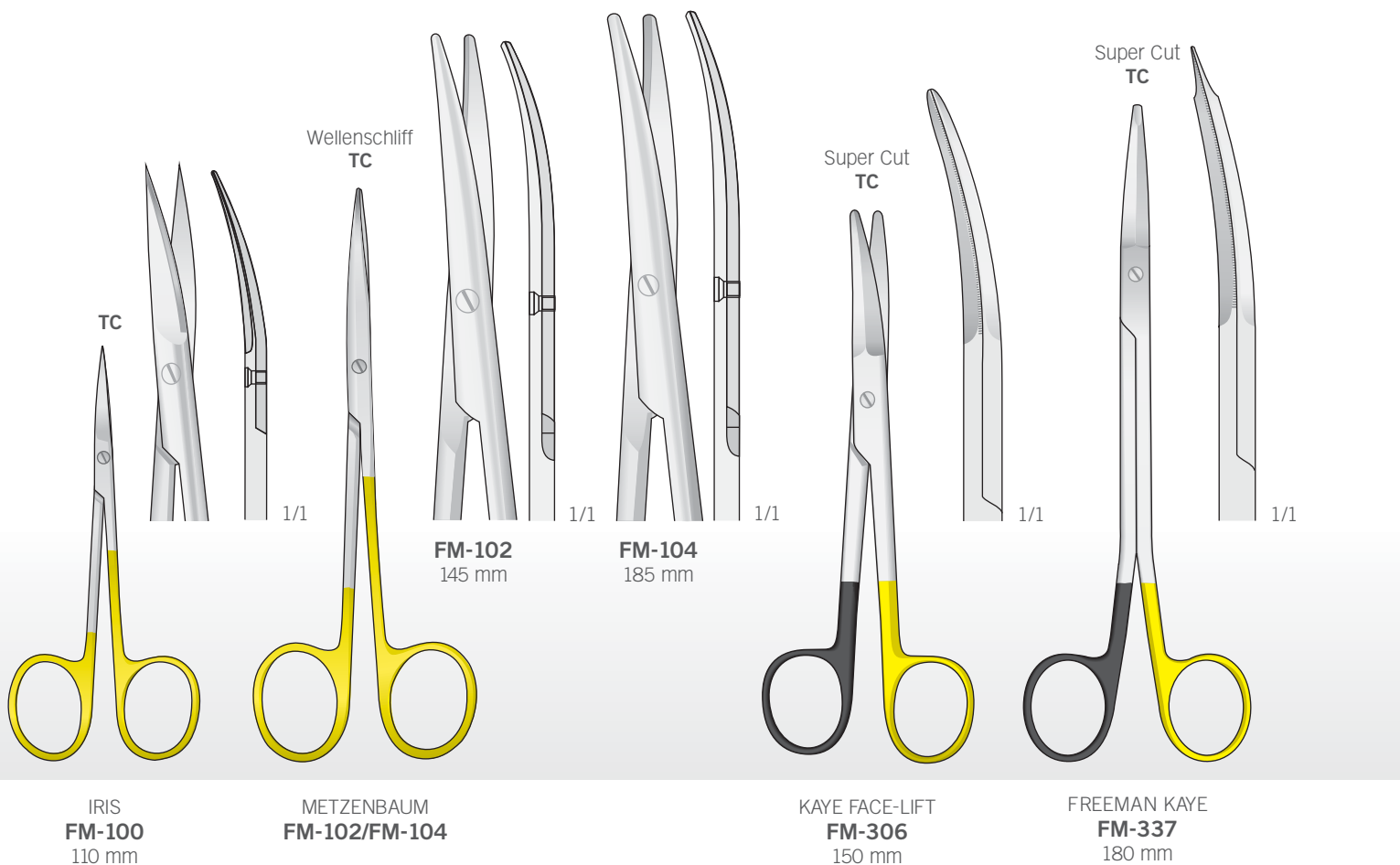



General Surgery
Allgemeine Chirurgie
Chirurgie générale
Cirugía General
Chirurgia Generale

Super Cut

Mit Hartmetalleinsätzen - Mit einer Schneide gezahnt
Tungsten-carbide scissors - With one blade serrated
Forbici con lame al carburo di tungsteno - Con una lama zigrinata
Tijeras con placas de carburo de tungsteno - Con una hoja dentada
Siseaux vec plaquettes en carbure de tungstène - Avec une lame dentée

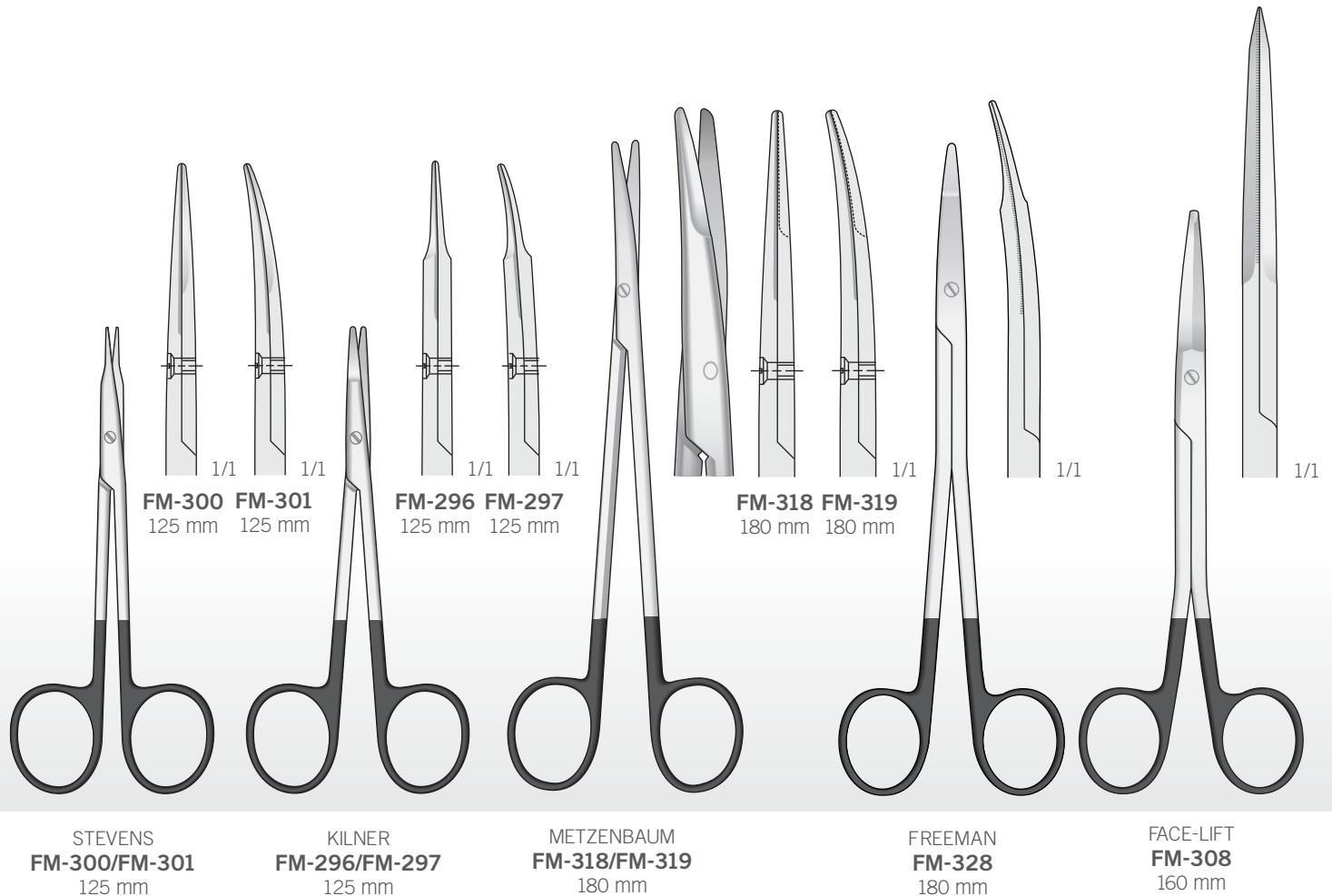



ADSON

Chirurgische Pinzetten - Tissue Forceps
 Pinzette chirurgiche - Pinzas quirúrgicas
 Pincas chirurgicaux

Mit Hartmetalleinsätzen
 Tungsten-carbide scissors
 Con punta al carburo
 di tungsteno
 Con punta de carburo
 de tungsteno
 Avec plaquettes
 en carbure de tungstène

Mit Fadenplatte
 With tying platform
 Con piano prendifilo
 Con plataforma
 Avec plateaux pour monofil

Micro

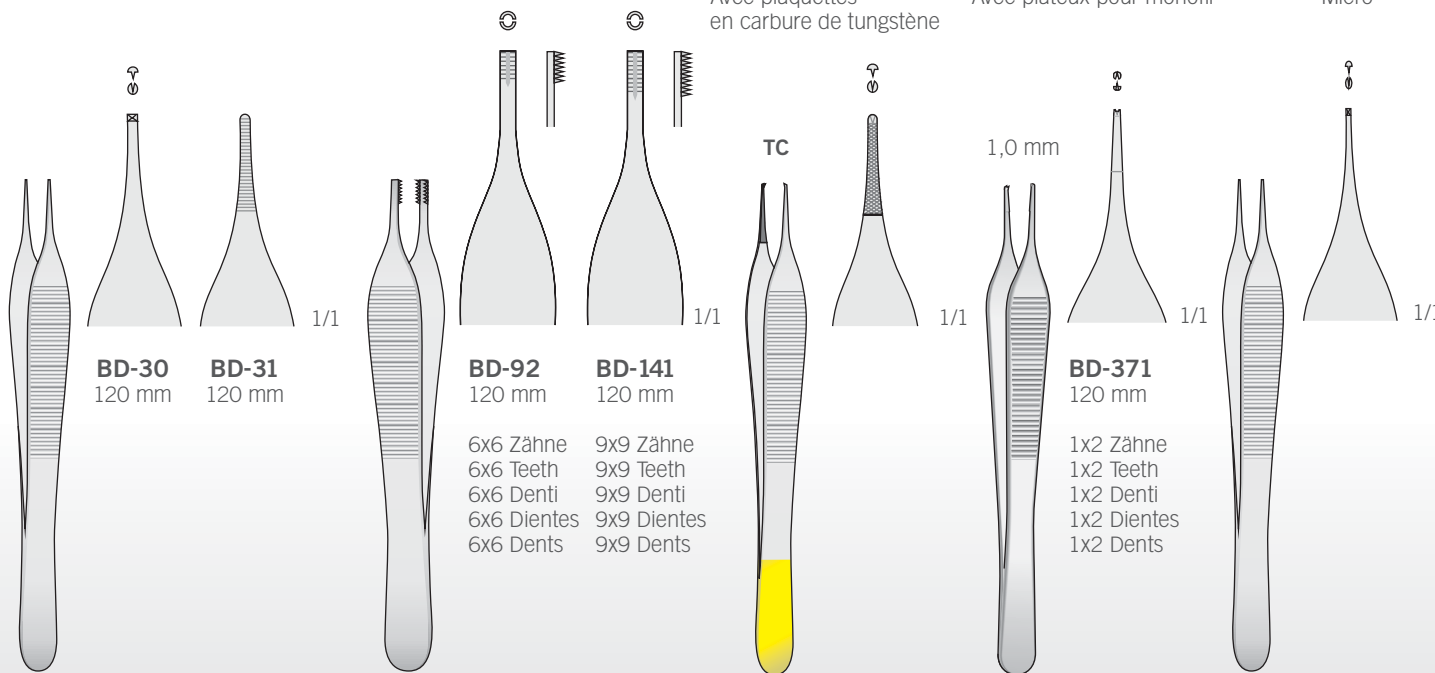

ADSON
BD-30/BD-31

ADSON-BROWN
BD-92/BD-141
 120 mm

ADSON
BD-250
 120 mm

ADSON
BD-371
 120 mm

ADSON
BD-73
 120 mm



General Surgery
 Allgemeine Chirurgie
 Chirurgie générale
 Cirugía General
 Chirurgia Generale

Atraumatische pinzetten
 Non-traumatic vascular tissue forceps
 Pinzette atraumatiche
 Pinzas atraumáticas
 Pincas atraumáticas

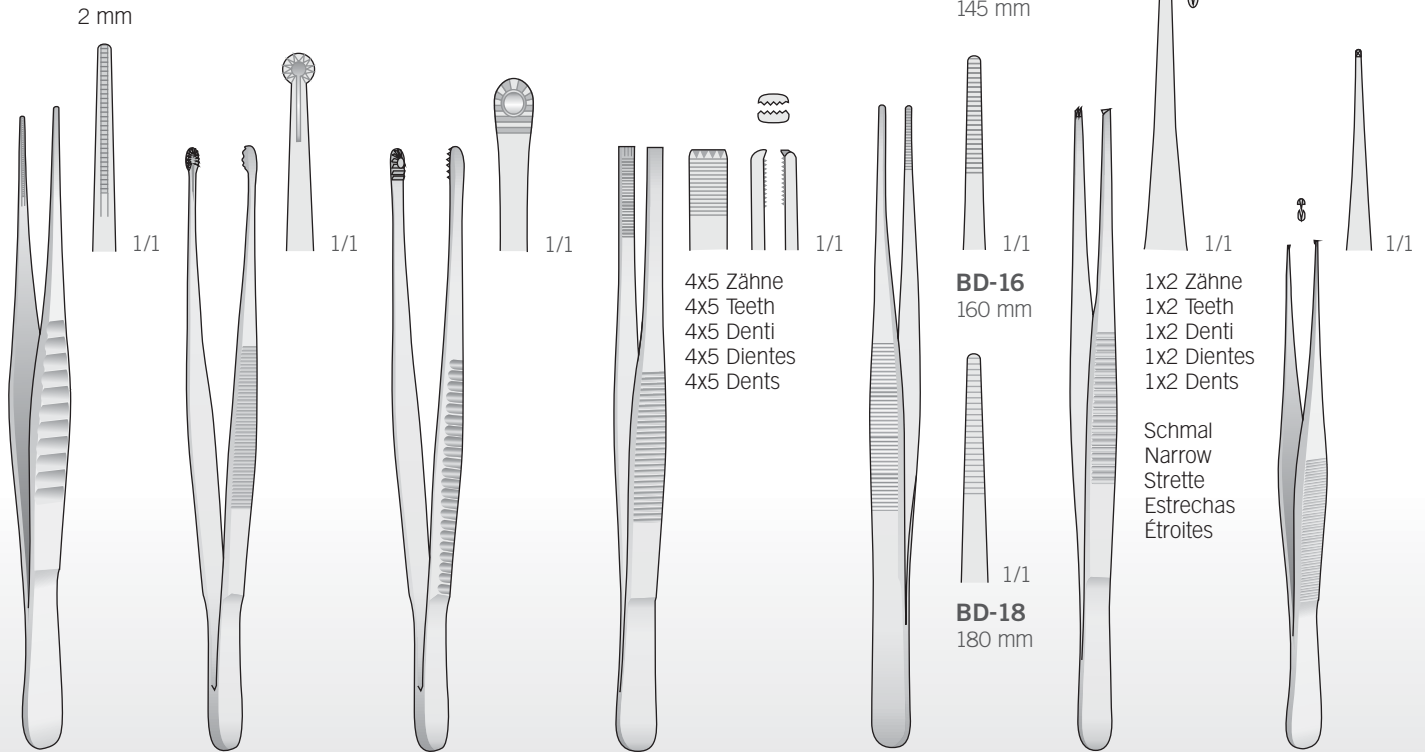

DE BAKEY
BD-80
 160 mm

SELMAN
BD-157
 150 mm

RUSSIAN
BD-27
 150 mm

ADLERKREUTZ
BD-28
 150 mm

BD-16
 160 mm

BD-274
 160 mm

BD-42
 110 mm

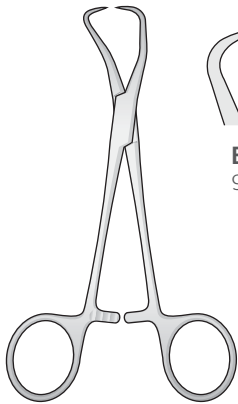

BACKHAUS
BF-41/BF-44



SCHAEDEL
BF-38
 85 mm



FAURE
BF-40
 85 mm

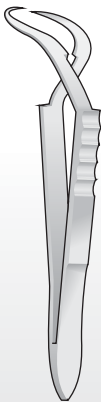

JONES
BF-48
 90 mm

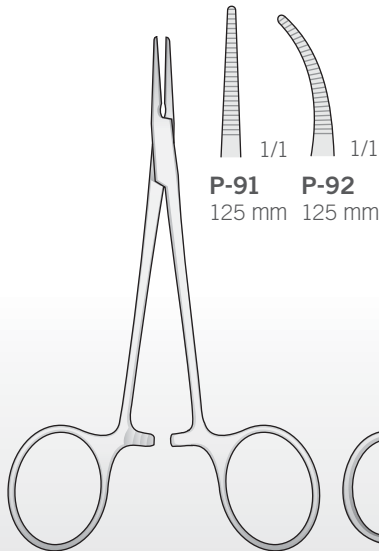

HALSTED
P-91/P-92
 125 mm

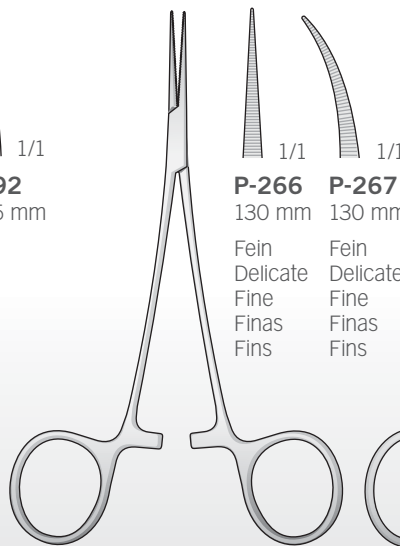

JACOBSON-MICRO
P-266/P-267
 130 mm

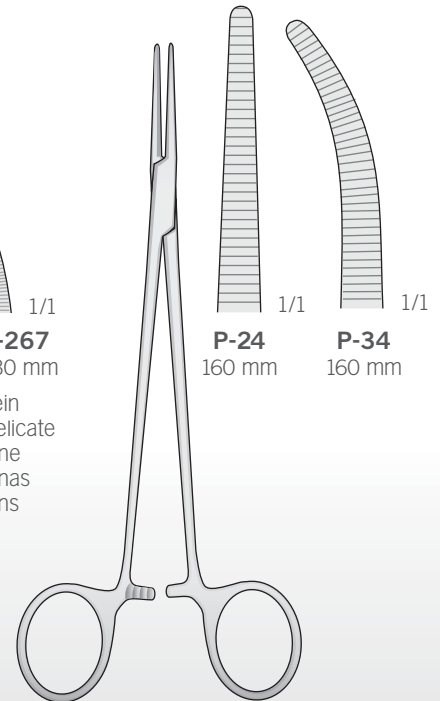

PEAN
P-24/P-34
 160 mm

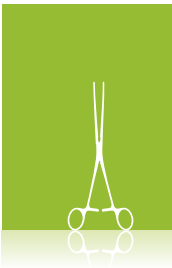

General Surgery
 Allgemeine Chirurgie
 Chirurgie générale
 Cirugía General
 Chirurgia Generale

Elastisch
 Elastic
 Elastische
 Elásticas
 Elastic



Atraumatische
 Atraumatic
 Atraumatiche
 Atraumáticas
 Atraumatiques

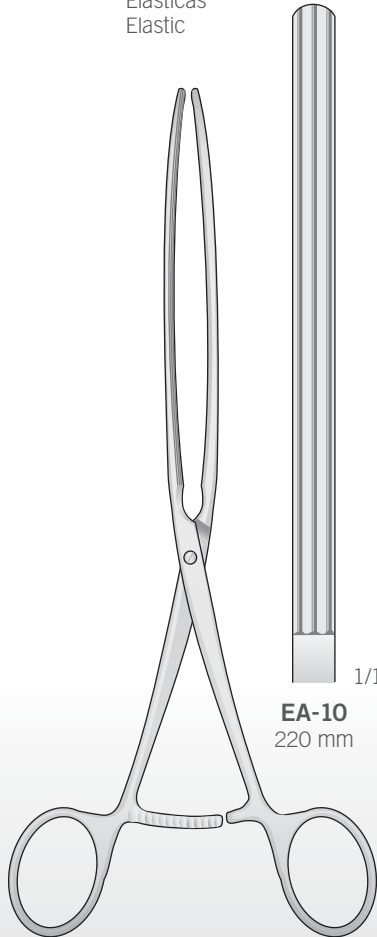

KOCHER
EA-10

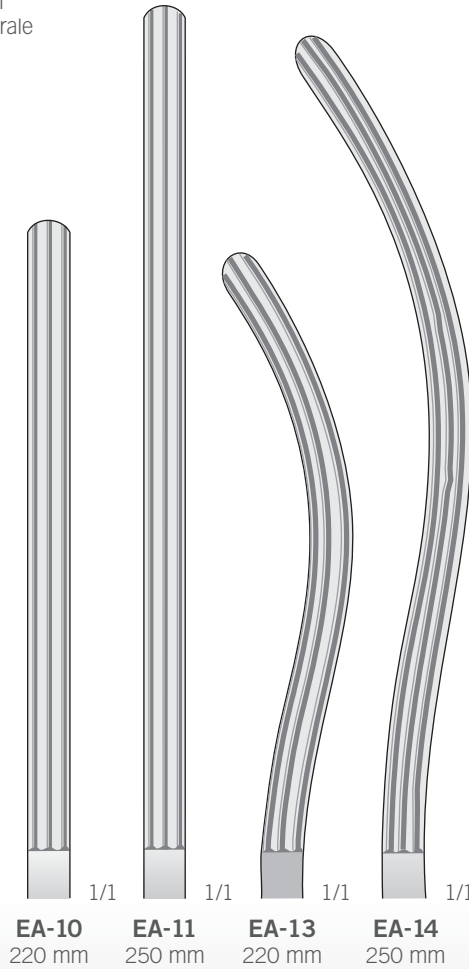

Darklemmen
 Intestinal Clamps
 Pinze intestinali
 Pinzas intestinales
 Pincas intestinales

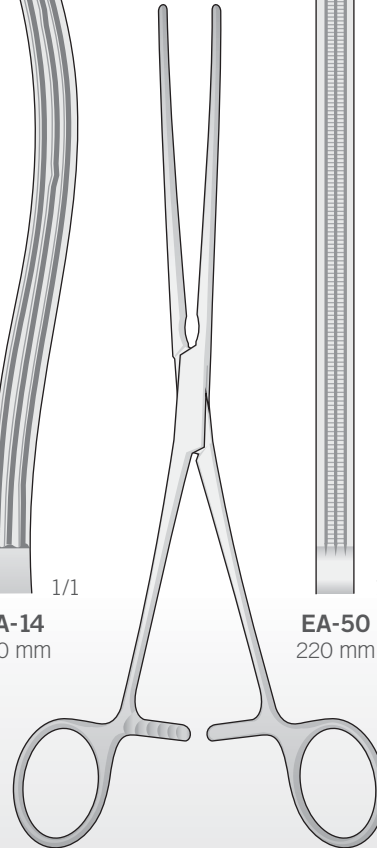

KOCHER
EA-53

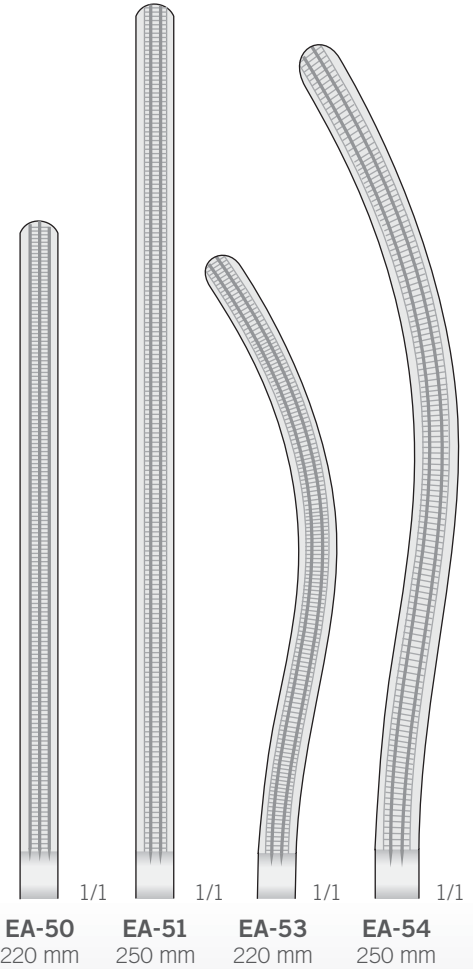

Darklemmen
 Intestinal Clamps
 Pinze intestinali
 Pinzas intestinales
 Pincas intestinales



Atraumatische
 Atraumatic
 Atraumatiche
 Atraumáticas
 Atraumatiques

Atraumatische
 Atraumatic
 Atraumatiche
 Atraumáticas
 Atraumatiques



Atraumatische
 Atraumatic
 Atraumatiche
 Atraumáticas
 Atraumatiques

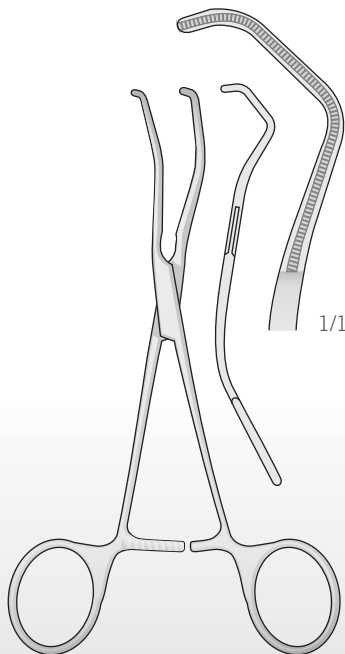

COOLEY
FB-16
 160 mm

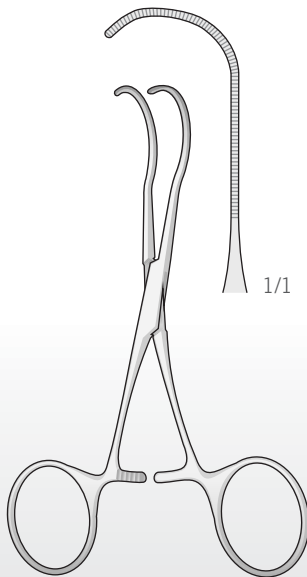

CASTANEDA
FB-256
 120 mm

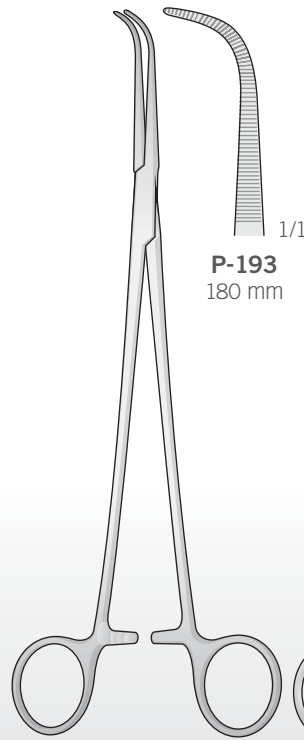

GEMINI
P-193

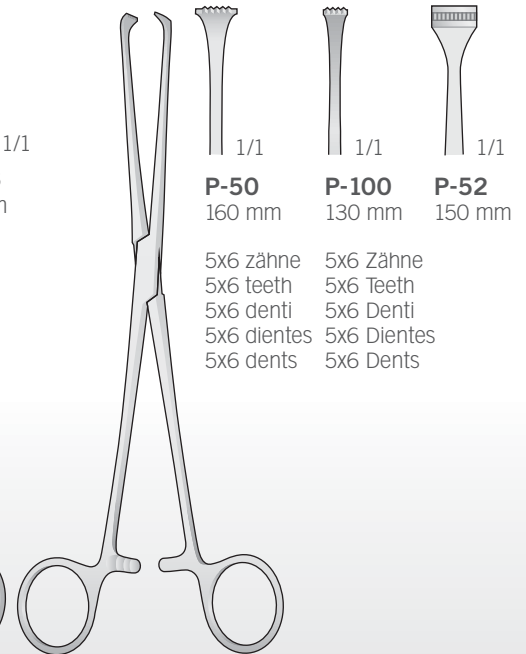

ALLIS
P-50/P-100

P-193
 180 mm

P-50
 160 mm

P-100
 130 mm

P-52
 150 mm

5x6 zähne
 5x6 teeth
 5x6 denti
 5x6 dientes
 5x6 dents

5x6 Zähne
 5x6 Teeth
 5x6 Denti
 5x6 Dientes
 5x6 Dents



General Surgery
 Allgemeine Chirurgie
 Chirurgie générale
 Cirugía General
 Chirurgia Generale

Fein-modell - Delicate Model
 Modello fine - Modelo delgada
 Mince modèle



DB-120 DB-121 DB-122
 L.85 mm L.140 mm L.165 mm

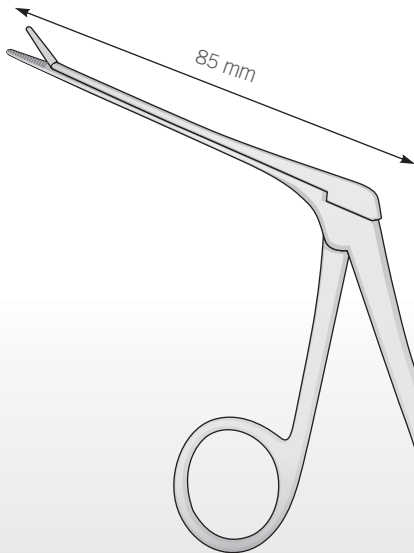

HARTMANN
DB-120/DB-121/DB-122
 L. 85 mm

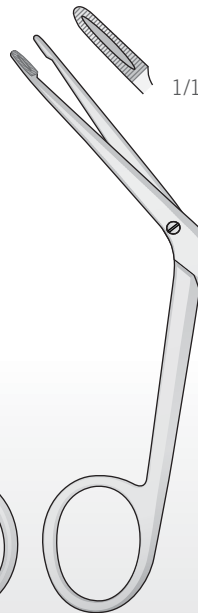

HARTMANN
DB-114
 140 mm

Absaugkanülen- Vacuums - Aspiratori
 Aspiradoras - Aspirateurs

GF-75
 5x2 mm
 190 mm



GF-76
 6x2,5 mm
 200 mm



GF-77
 7x3 mm
 200 mm

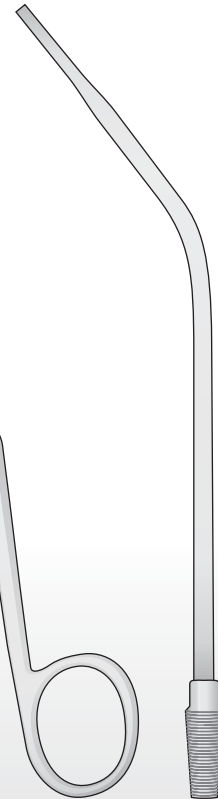

GF-75/GF-77
 200 mm

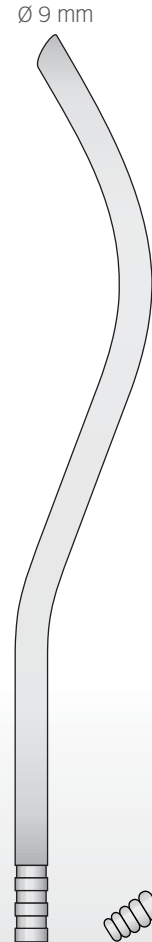

GF-09
 230 mm

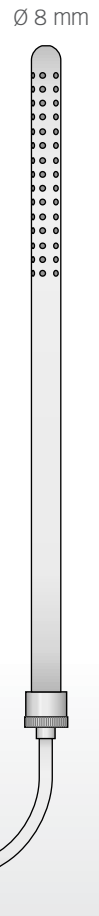

POOLE
GF-29
 220 mm

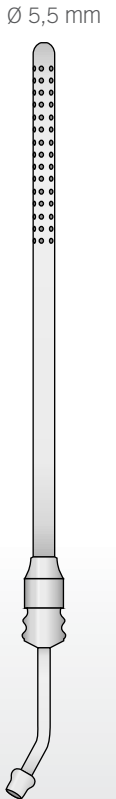

POOLE
GF-22
 190 mm

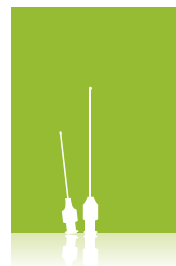

Saug- und Spülinstrumente
 Aspirating and Irrigating instruments
 Strumenti per aspirazione e lavaggio
 Instrumentos de aspiración y de lavado
 Instruments à aspiration et à irrigation

Ø 1,5 mm



OL-36
80 mm

Ø 1 mm



OL-22
50 mm

Ø 4 mm



SCHMID
OL-31
150 mm

Ø 5 mm



SCHMID
OL-32
150 mm

Ø 6 mm



SCHMID
OL-33
150 mm

Ø 2 mm



VF-102
170 mm

Ø 4 mm



VF-102M
170 mm

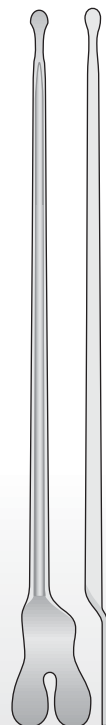

PF-19
180 mm

Ø 1,5 mm



PF-22
145 mm

Knochenmark-Biopsie
 Marrow biopsy
 Biopsia del midollo
 Biopsia de médula
 Biopsie de la moelle

Haut-Trephinen
 Dermal punches
 Punche da biopsia
 Trépanos cutáneos
 Tréphanes cutanées

Ø 1,8 mm

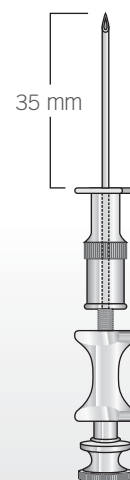

KLIMA-ROSEGGER
OL-40
100 mm

5 mm



KEYES
FL-152
100 mm

Ø 1 mm



HEPARIN
OL-07
60 mm

Ø 1,5 mm



HEPARIN
OL-08
60 mm

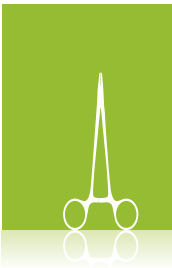

General Surgery
 Allgemeine Chirurgie
 Chirurgie générale
 Cirugía General
 Chirurgia Generale

Empfohlen für Nähnadeln - Recommended for suture needles
 Raccomandato per aghi da sutura - Recomendado para agujas de sutura
 Recommandé pour les aiguilles à suture



Standard - Regular - Regolare
 Regular - Regulaire
2.0, 3.0, 4.0



Fein - Fine - Fine
 Fino - Fin
3.0, 4.0, 5.0, 6.0



Mikro - Micro - Micro
 Micro - Micro
6.0, 7.0, 8.0, 9.0



Glatt - Smooth - Liscia
 Lisa - Lisse
7.0, 8.0, 9.0, 10.0

Nadelhalter mit Hartmetalleinlagen - Needle Holders with tungsten-carbide inserts
 Portaghi con inserti al tungsteno - Portaagujas con placas de carburo de tungsteno
 Porte aiguilles avec plaquettes en carbure de tungstène

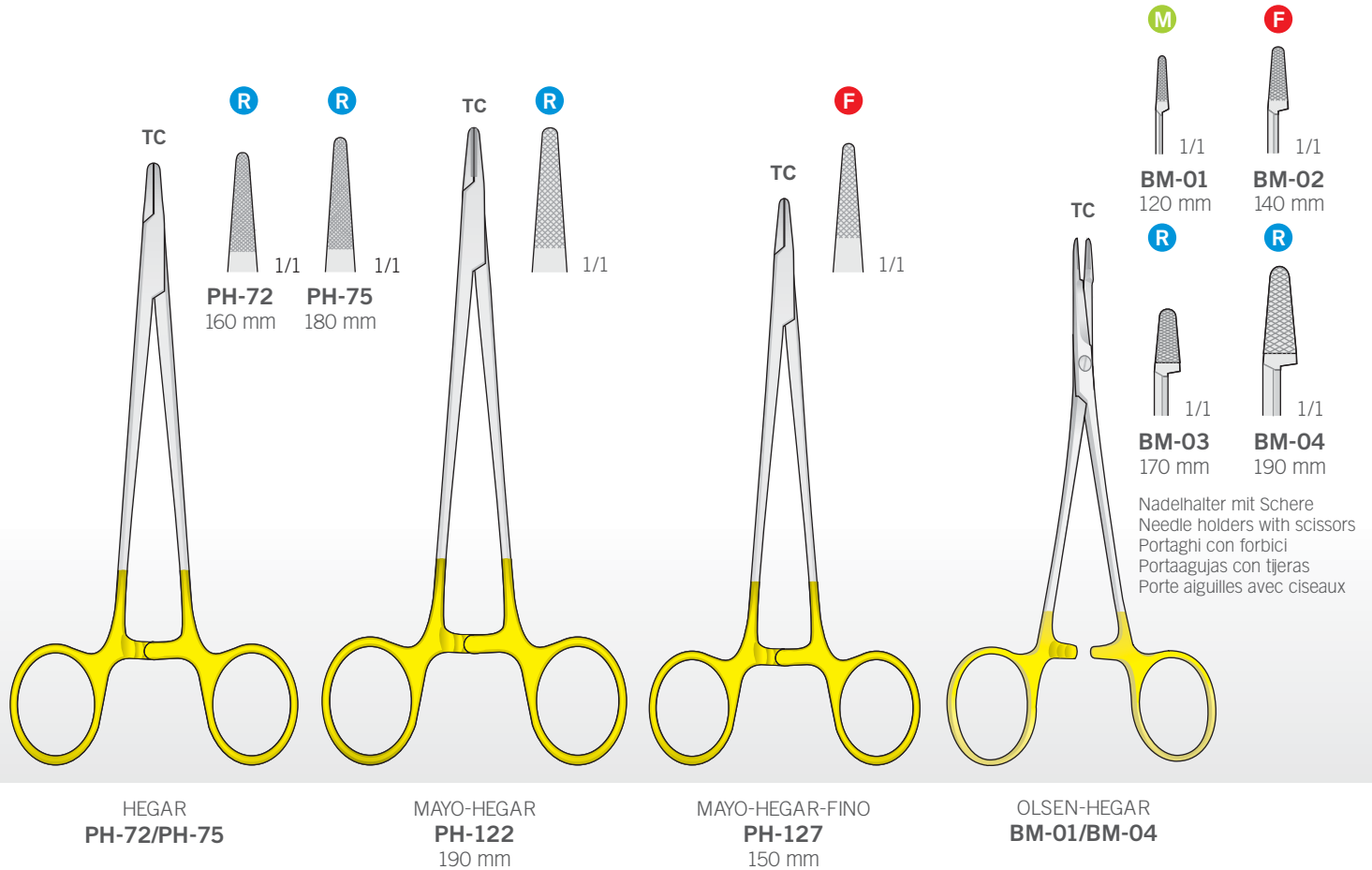

Empfohlen für Nähnadeln - Recommended for suture needles
 Raccomandato per aghi da sutura - Recomendado para agujas de sutura
 Recommandé pour les aiguilles à suture

R



Standard - Regular - Regolare
 Regular - Régulière
2.0, 3.0, 4.0

F



Fein - Fine - Fine
 Fino - Fin
3.0, 4.0, 5.0, 6.0

M



Mikro - Micro - Micro
 Micro - Micro
6.0, 7.0, 8.0, 9.0

S



Glatt - Smooth - Liscia
 Lisa - Lisse
7.0, 8.0, 9.0, 10.0

General Surgery
 Allgemeine Chirurgie
 Chirurgie générale
 Cirurgia General
 Chirurgia Generale

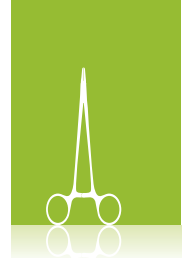

Nadelhalter mit Hartmetalleinlagen - Needle Holders with tungsten-carbide inserts
 Portaghi con inserti al tungsteno - Portaagujas con placas de carburo de tungsteno
 Porte aiguilles avec plaquettes en carbure de tungstène

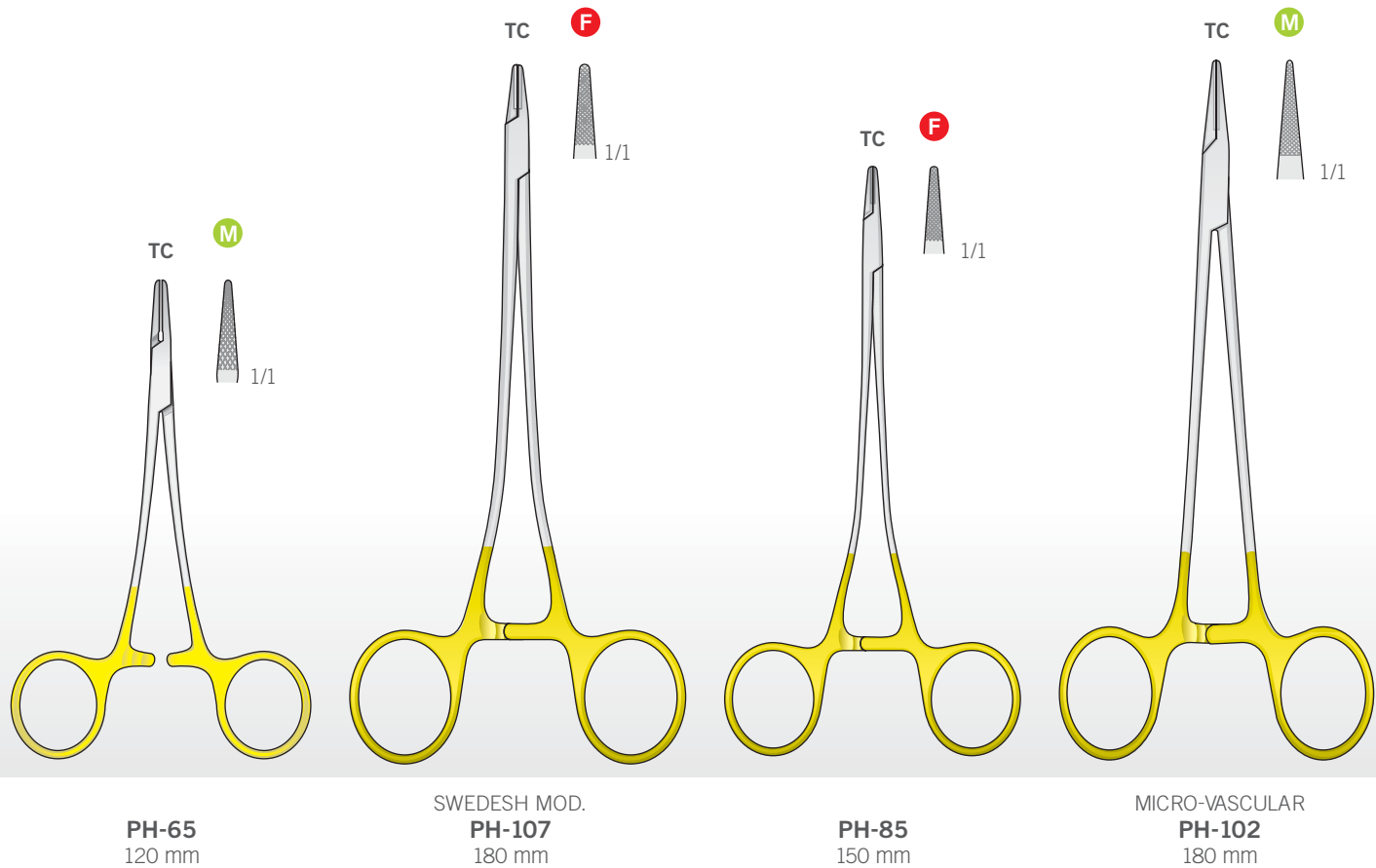

PH-65
120 mm

SWEDESH MOD.
PH-107
180 mm



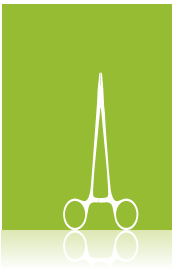

PH-85
150 mm

MICRO-VASCULAR
PH-102
180 mm



General Surgery
 Allgemeine Chirurgie
 Chirurgie générale
 Cirugía General
 Chirurgia Generale

Empfohlen für Nähnadeln - Recommended for suture needles
 Raccomandato per aghi da sutura - Recomendado para agujas de sutura
 Recommandé pour les aiguilles à suture

R		Standard - Regular - Regolare Regular - Regulaire 2.0, 3.0, 4.0	F		Fein - Fine - Fine Fino - Fin 3.0, 4.0, 5.0, 6.0
M		Mikro - Micro - Micro Micro - Micro 6.0, 7.0, 8.0, 9.0	S		Glatt - Smooth - Liscia Lisa - Lisse 7.0, 8.0, 9.0, 10.0

Kräftiges Modell - Heavy pattern
 Modello robusto - Modelo sólido
 Modèle robuste

Mit Schere - With Scissors
 Con Forbice - Con Tijeras
 Avec Ciseaux

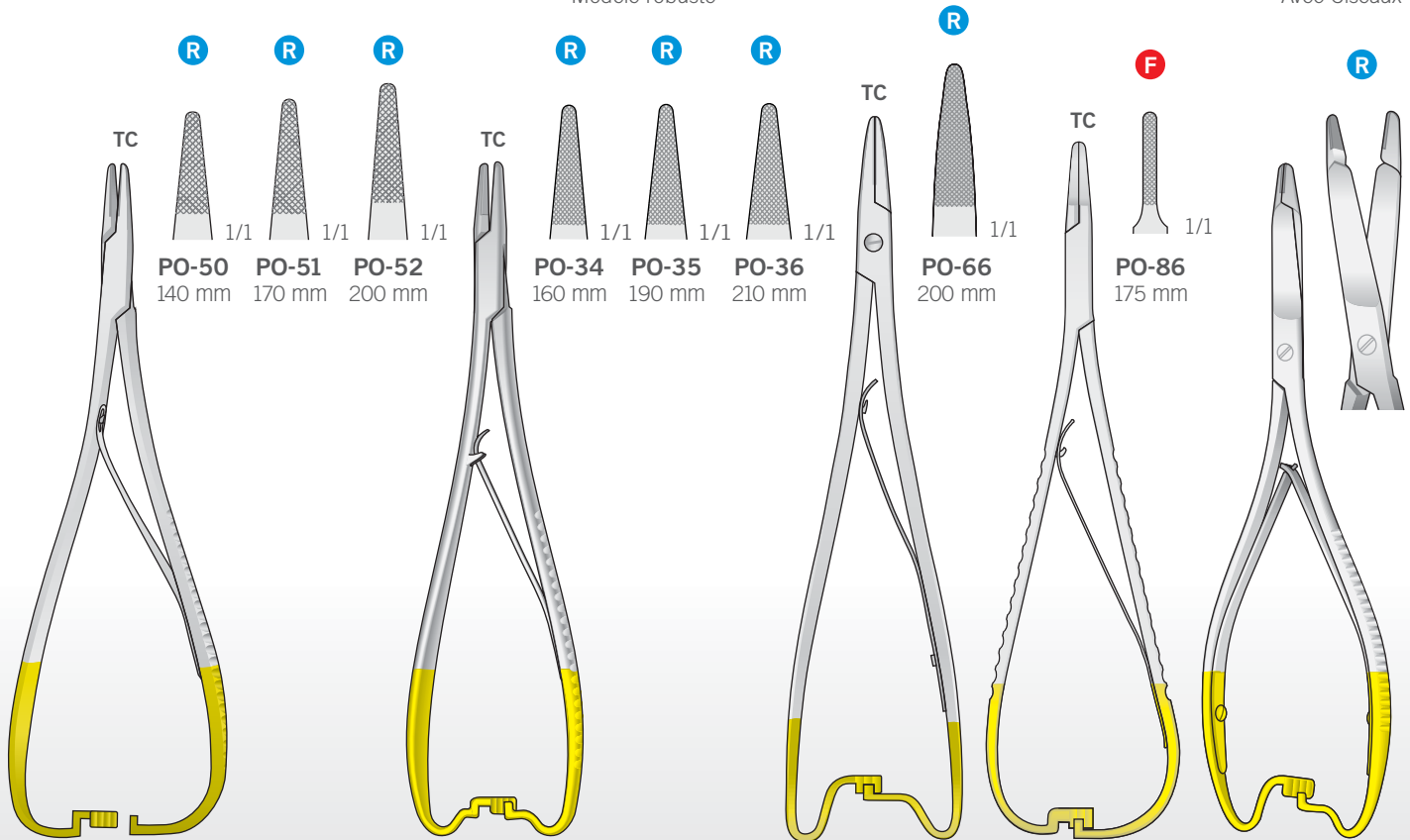

MATHIEU
PO-50/PO-52

MATHIEU
PO-34/PO-36

MATHIEU
PO-66
 200 mm

LICHTENBERG
PO-86
 175 mm

OLSEN-MATHIEU
PO-95 140 mm
PO-98 170 mm
PO-100 200 mm

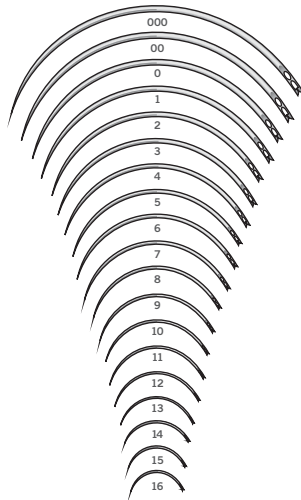

Art.	Eye	Profile
BN-502/000		▼
BN-502/00		▼
BN-502/0		▼
BN-502/1		▼
BN-502/2		▼
BN-502/3		▼
BN-502/4		▼
BN-502/5		▼
BN-502/6		▼
BN-502/7		▼
BN-502/8		▼
BN-502/9		▼
BN-502/10		▼
BN-502/11		▼
BN-502/12		▼
BN-502/13		▼
BN-502/14		▼
BN-502/15		▼
BN-502/16		▼

Farbige Ringe aus Silikon zu kodieren Chirurgie-Kits
 Colored rings in silicone to encode surgical kits
 Anelli colorati in silicone per codificare kit chirurgici
 Anillos de colores en silicona para codificar set quirúrgico
 Bagues colorées en silicone pour encoder des kits de chirurgie



DB-941 box 120 pcs.
DB-942 box 175 pcs.

Farbige Bänder
 Colored ribbons
 Nastri colorati per codificare kit chirurgici
 Cintas de colores
 Rubans colorés



DB-940
 box 8 colours



Dental Surgery
 Zahnärztliche Chirurgie
 Chirurgie Dentaire
 Cirugía Dental
 Chirurgia Dentale

Mini-Wurzelheber
 Root Mini Elevators
 Mini Leve per radici
 Mini Elevadores para raíces
 Mini Elévateurs à racines

Luxatoren für Schneidezähne
 Incisors Luxators
 Lussatori per incisivi
 Luxadores para incisivos
 Luxateurs pour incisives

Erweitert Wange
 Widens Cheek
 Allargaguancia
 Amplía-mejilla
 Élargit la joue

Concave botton
 Ø 1,0 mm

Concave top
 Ø 1,0 mm

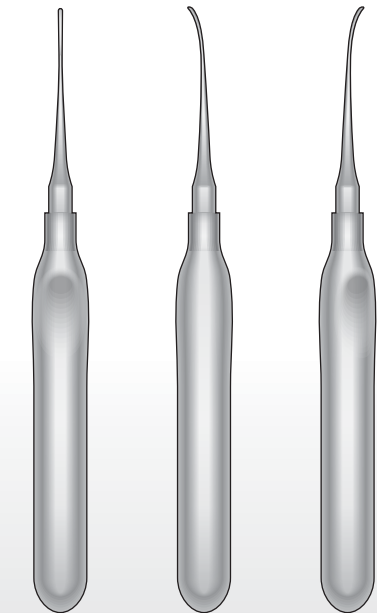

Ø 1,0 mm

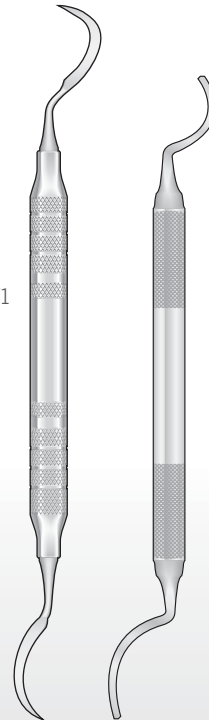

Mundsperrer
 Mouth Gags
 Apribocca
 Abreboca
 Ecateur buccal

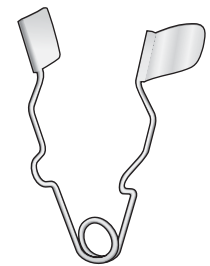

VF-121
 60 mm

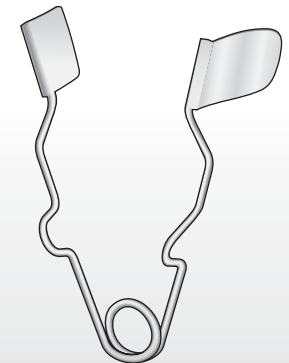

US DL-401
 155 mm

US DL-402
 155 mm

US DL-403
 155 mm

US DL-500
 130 mm

MIR-12
 155 mm

VF-127
 185 mm

VF-126
 160 mm

SCHMIDTKE
VF-120
 120 mm

VF-122
 85 mm

Katzen - Cats
Gatti - Gatos
Chats

VH-48 60 mm
VH-49 80 mm

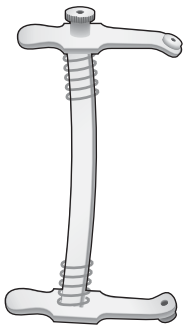

Hunde - Dogs
Canis - Perros
Chiens

VH-50 110 mm
VH-51 160 mm

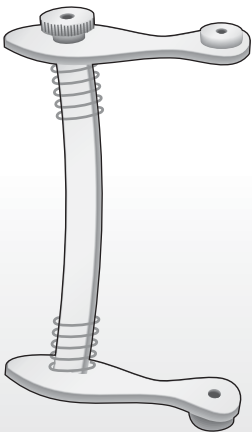

VH-48/VH-51

TC

Mit Hartmetalleinsätzen
With Hard Metal Inserts
Con punte in metallo duro
Con puntas de metal duro
Avec mors en métal dur

Zange zum Abkneifen
von Ferkeelzähnen
Forceps for trimming teeth
for small animals
Pinza per tagliare denti
di piccoli animali
Pinza para cortar dientes
de pequeños animales
Pinces à couper les dents
des petits animaux

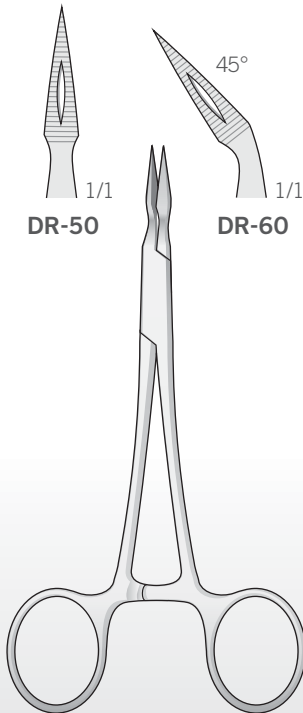

DR-50

DR-60

STIEGLITZ
DR-50/DR-60
140 mm

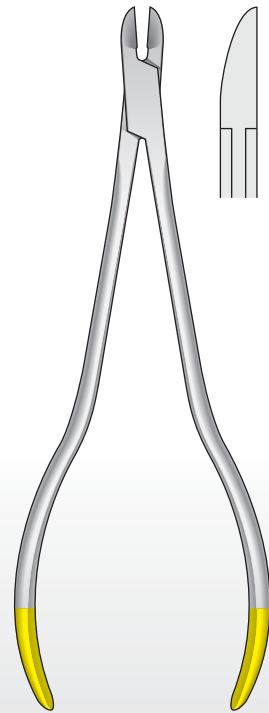

LX-98
175 mm

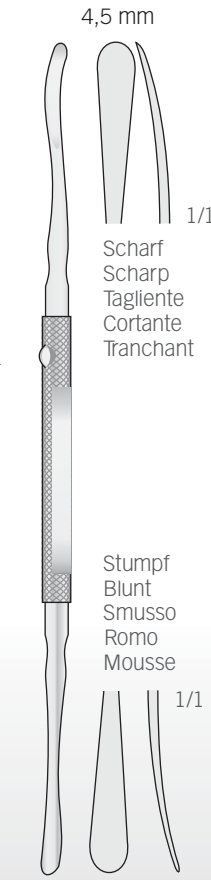

FREER
180 mm

Dental Surgery
Zahnärztliche Chirurgie
Chirurgie Dentaire
Cirugía Dental
Chirurgia Dentale

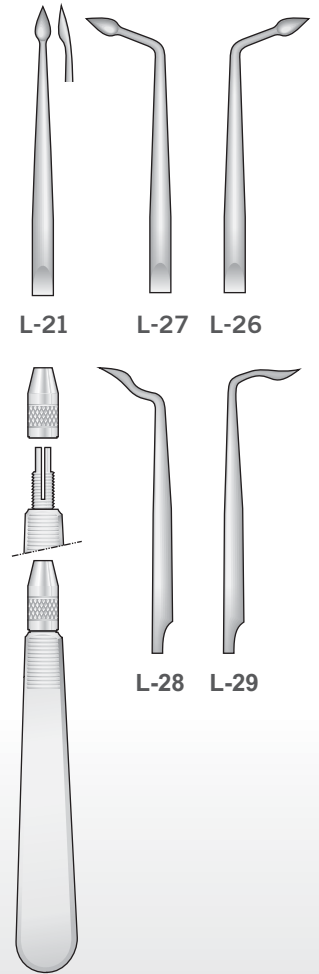
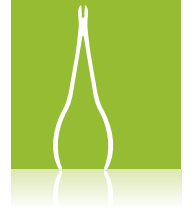

L-21

L-27

L-26

L-28

L-29

SD-M

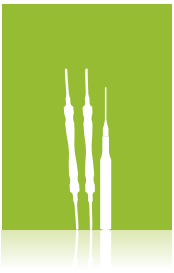

Dental Surgery
 Zahnärztliche Chirurgie
 Chirurgie Dentaire
 Cirugía Dental
 Chirurgia Dentale

2,2 mm

3,0 mm

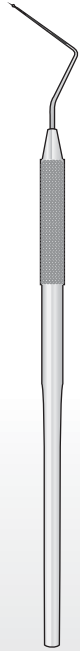
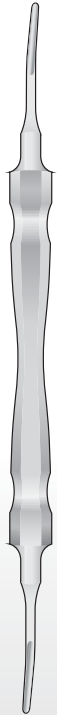

Eine Seite gezahnt
 One side serrated
 Un lato dentellato
 Un lado dentado
 Dentelure sur un côté



DL-78
155 mm

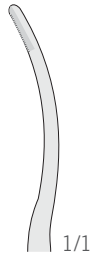

DL-79
155 mm

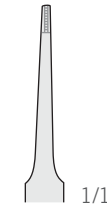

DA-02
130 mm



Rhodiumspiegel
 Rhodium Mirror
 Specchietto rodiato
 Espejo de rodio
 Miroir au rhodium



Pack. 12 pcs.

RH-4 22 mm

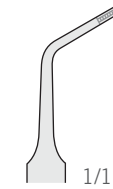

DA-01
130 mm

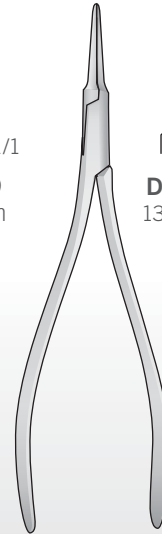

DA-01/DA-02
130 mm



MA-2
125 mm

Massiv
 Solid
 Pieno
 Sólido
 Massif

Rostfrei
 Stainless
 Inox
 Inoxidable
 Inoxydable

FAHRENKRUG
DL-05
190 mm

FAHRENKRUG
DL-06
190 mm

CP-11
SM-11
160 mm

CP-12S
SM-13
160 mm

DL-78/DL-79
155 mm

Fig. 100L Fig. 100R



Wurzelheber
 Root Elevators
 Leve per radici
 Elevadores para raíces
 Elévateurs à racines

Luxatoren
 Luxators
 Lussatori
 Luxadores
 Luxateurs

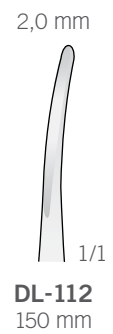
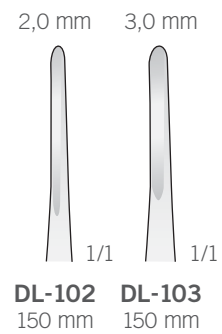
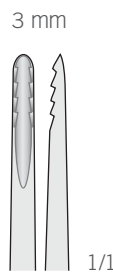
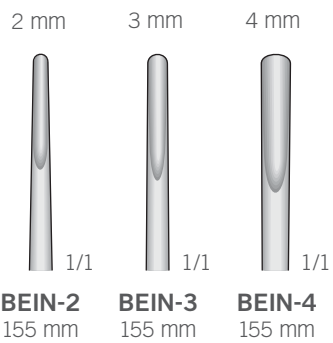

BEIN-2/BEIN-4
155 mm

BEIN-2Z
155 mm

DL-102/DL-103
150 mm

DL-112
150 mm

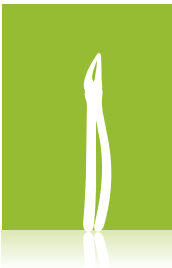

Dental Surgery
 Zahnärztliche Chirurgie
 Chirurgie Dentaire
 Cirugía Dental
 Chirurgia Dentale

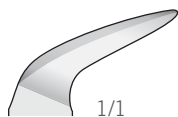

1/1

56

Zum Trennen Unterer Molarenwurzeln
 For separating lower molar roots
 Per radici dei molari inferiori, presa in profondità
 Para separar raíces de molares inferiores profundos
 Pour séparer les racines des molaires inférieures

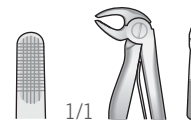

1/1

PEB-5

Untere Schneidezähne
 Lower incisors
 Incisivi inferiori
 Incisivos inferiores
 Incisives inférieures

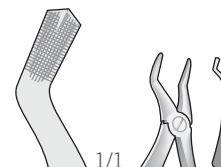

1/1

PEB-3

Obere Molaren
 Upper molars
 Molari superiori
 Molares superiores
 Molaire supérieures

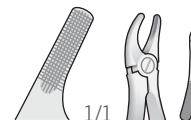

1/1

PEB-2

Obere Prämolaren
 Upper Premolars
 Premolari superiori
 Premolares superiores
 Prémolaires supérieures

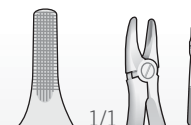

1/1

PEB-1

Obere Schneidezähne
 Upper Incisors
 Incisivi superiori
 Incisivos superiores
 Incisives supérieures

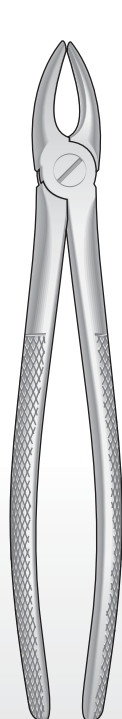

1

Obere Schneide
 und Eckzähne

Upper Incisors
 and cuspids

Incisivi e canini
 superiori

Incisivos y caninos
 superiores

Incisives et canines
 supérieures

1

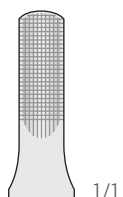

1/1



30

Obere Wurzeln

Upper Roots

Radici superiori

Raíces superiores

Racines supérieures

30/56

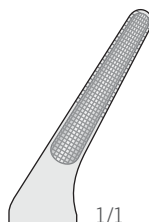

1/1

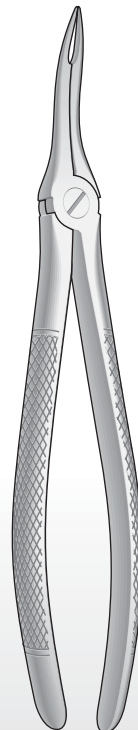

49

Obere Wurzeln
 sehr feine

Upper very
 fine roots

Radici superiori
 molto sottili

Raíces superiores
 muy finas

Racines supérieures
 très fines

49

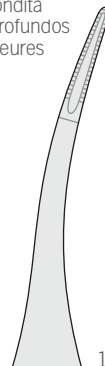

1/1

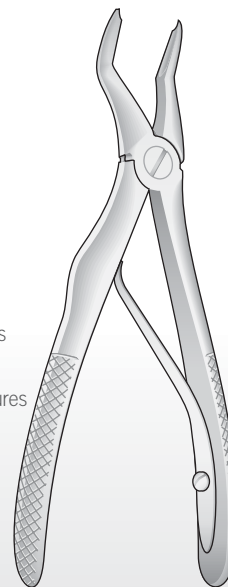

PEB-1/PEB-5



Universal Küretten
 Universal Curettes
 Curette universali
 Curetas universales
 Curettes universelles

Küretten
 Curettes
 Curette
 Curetas
 Curettes

Scaler

Periotome
 Periotomes
 Periotomi
 Periostótomos
 Périotomes

Ø 8.0 mm

Ø 8.0 mm

Ø 8.0 mm

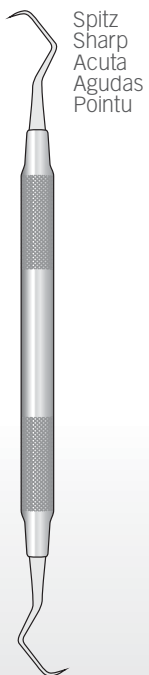

Spitz
 Sharp
 Acuta
 Agudas
 Pointu

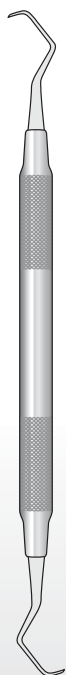

Stumpf
 Blunt
 Smussa
 Romas
 Mousse

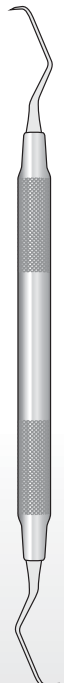

Spitz
 Sharp
 Acuta
 Agudas
 Pointu



GRACEY
 CU-1/2



GRACEY
 CU-3/4



GOLDMAN-FOX
 718-277



TOWNER-
 JAQUETTE
 719-111



MC-11
 160 mm



MC-12
 160 mm



MC-13
 160 mm

718-M23
 165 mm

718-M23A
 165 mm

718-M23B
 170 mm

GRACEY
 CU-1/2/CU-3/4

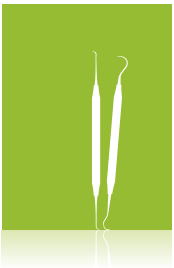

Dental Surgery
 Zahnärztliche Chirurgie
 Chirurgie Dentaire
 Cirugía Dental
 Chirurgia Dentale

Periostale
 Periosteal
 Scollatori
 Perióstica
 Décolleur

Scharf
 Sharp
 Taglienti
 Afilado
 Tranchant

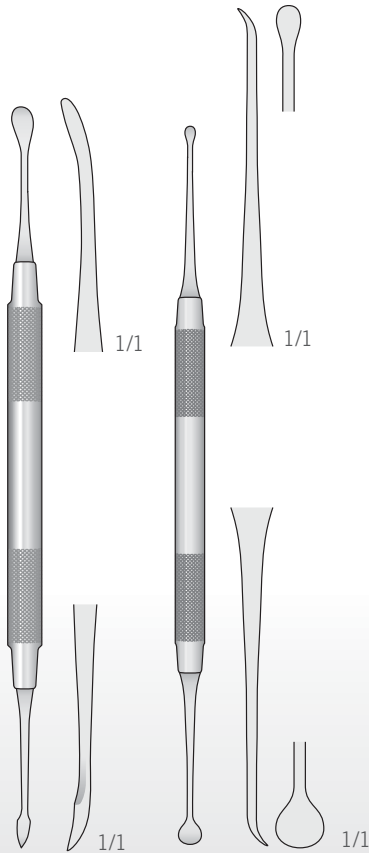

**MOLT
MO-8**
185 mm

**MOLT
MO-10**
180 mm

R-2

R-3

**HOLLENBACK
715-102
715-103**

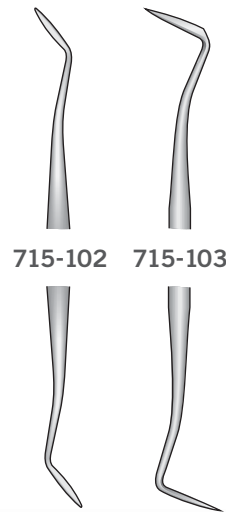

715-102 715-103

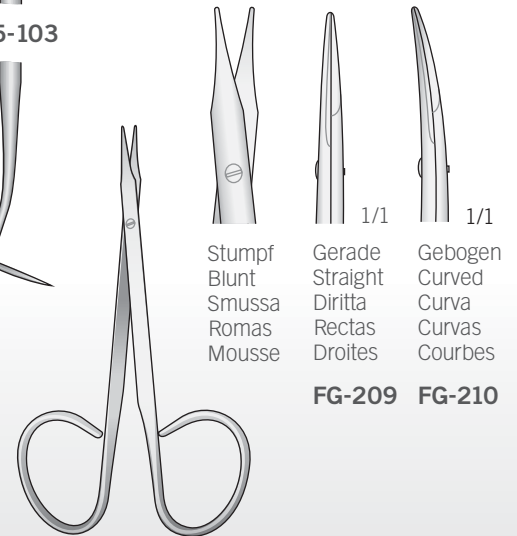

Stumpf
 Blunt
 Smussa
 Romas
 Mousse

Gerade
 Straight
 Diritta
 Rectas
 Droites

Gebogen
 Curved
 Curva
 Curvas
 Courbes

FG-209 FG-210

**STEVENS
FG-209/FG-210**
100 mm

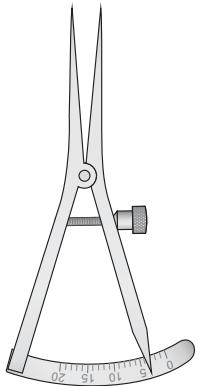

OR-17 - 90 mm
 Meßbereich: 0 - 20 mm
 Measuring range: 0 - 20 mm
 Campo di misura: 0 - 20 mm
 Alcance de medición: 0 - 20 mm
 Etendue de mesure: 0 - 20 mm

OR-12 - 170 mm
 Meßbereich: 0 - 40 mm
 Measuring range: 0 - 40 mm
 Campo di misura: 0 - 40 mm
 Alcance de medición: 0 - 40 mm
 Etendue de mesure: 0 - 40 mm

CASTROVIEJO
OR-12/OR-17

Augenlid
 Eyelid
 Blefarostati
 Párpado
 Paupière

Stumpf
 Blunt
 Smussa
 Romo
 Mousse

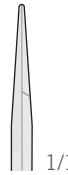

FD-64

Stumpf
 Blunt
 Smussa
 Romo
 Mousse



FD-41

Hornhaut Schere
 Corneal scissors
 Forbici corneali
 Tijeras de córnea
 Corneal ciseaux

Universal
 Universal
 Universale
 Universal
 Universel

NK-80	27 mm	5 mm
NK-82	34 mm	9 mm
NK-84	42 mm	12 mm
NK-86	42 mm	14 mm

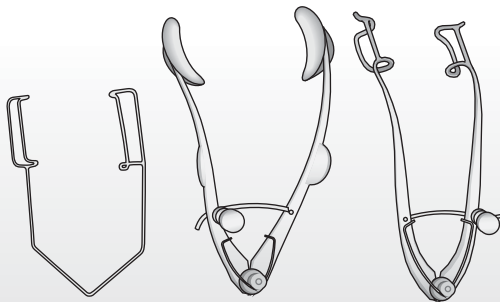

BARRAQUER
NK-80/NK-86
 52 mm

LISTER-BURCH
BV-04
 80 mm

WILLIAMS
BV-06
 80 mm

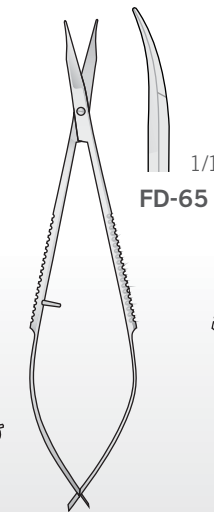

WESTCOTT
FD-64/FD-65
 120 mm

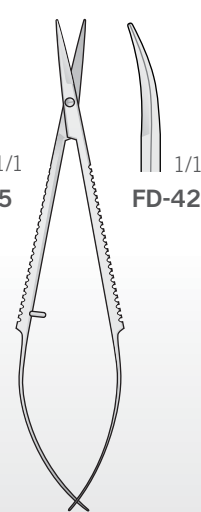

FD-41/FD-42
 120 mm



FD-11
 110 mm



CASTROVIEJO
FD-66/FD-67
 110 mm

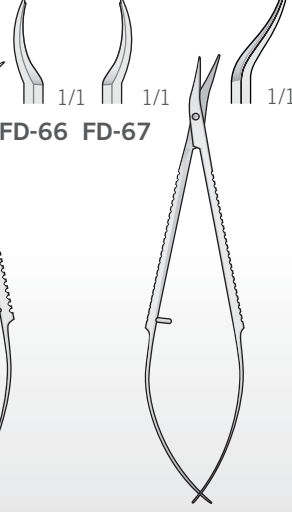

CASTROVIEJO
FD-68
 110 mm



Ophthalmology
Ophthalmologie
Ophtalmologie
Oftalmología
Oftalmologia

Ohne Sperre
Without Lock
Senza arresto
Sin cierre
Sans Arrêt

Atraumatische
Atraumatic
Atraumatiche
Atraumáticas
Atraumatiques

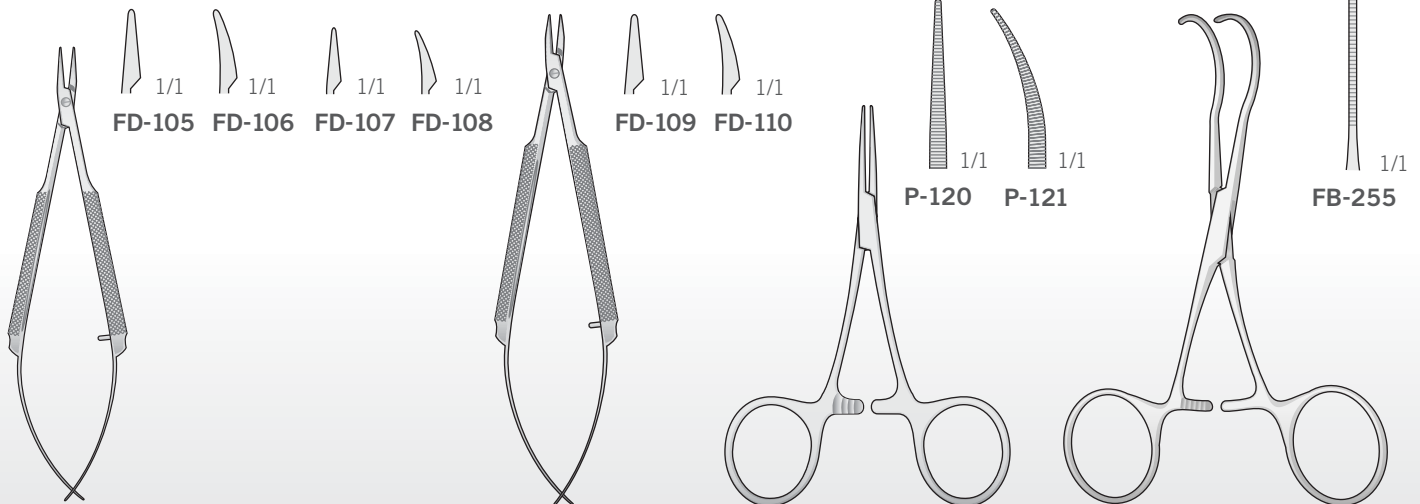

CASTROVIEJO
FD-105/FD-108
110 mm

CASTROVIEJO
FD-109/FD-110
125 mm

HARTMANN-BABY-MOSQUITO
P-120/P-121
95 mm

CASTANEDA
FB-255
120 mm

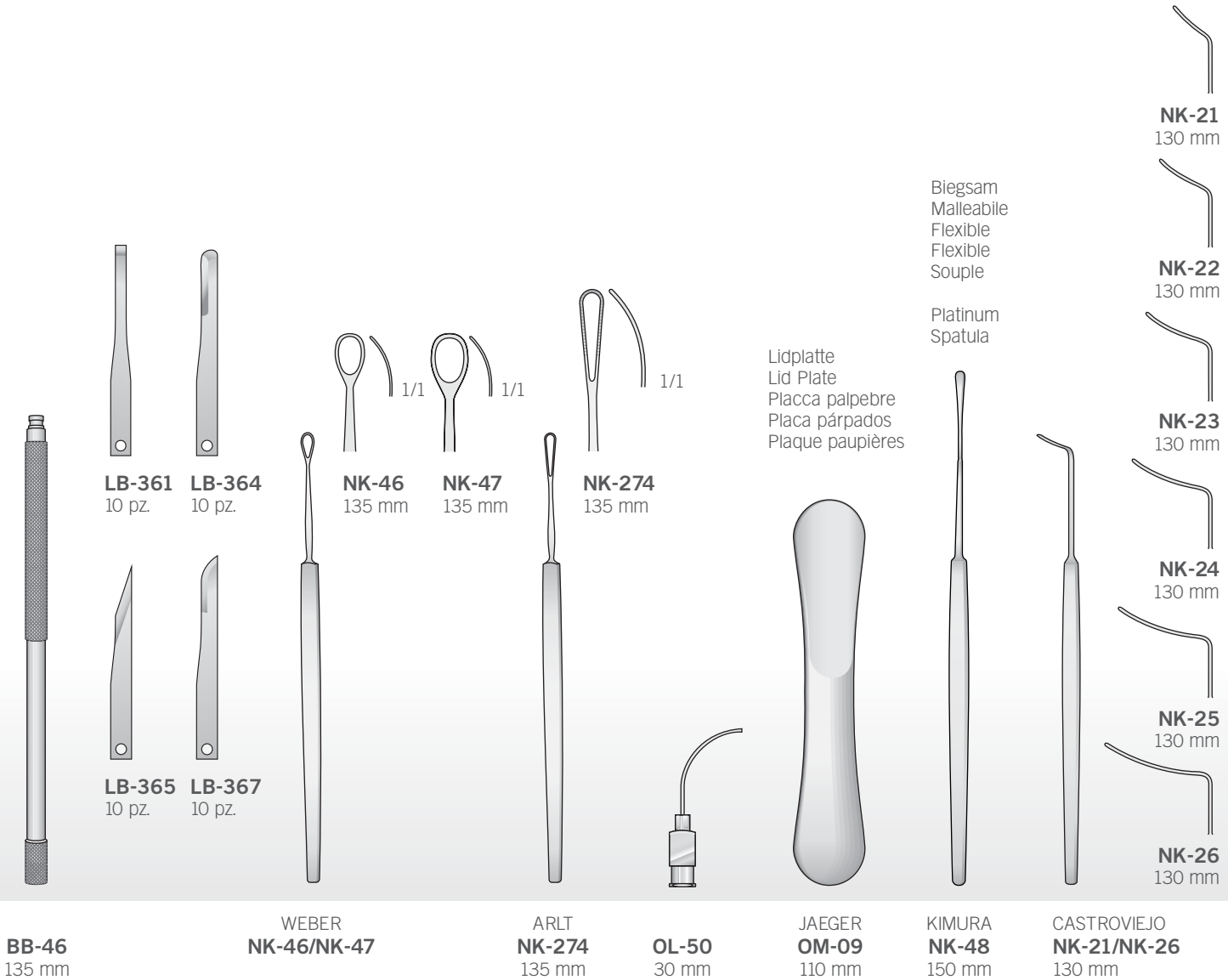



Ophthalmology
 Ophthalmologie
 Ophtalmologie
 Oftalmología
 Oftalmologia

Pinzetten dritte Augenlid
 Tweezers third eyelid
 Pinza terza palpebra
 Pinzas párpado tercero
 Pincés troisième paupière

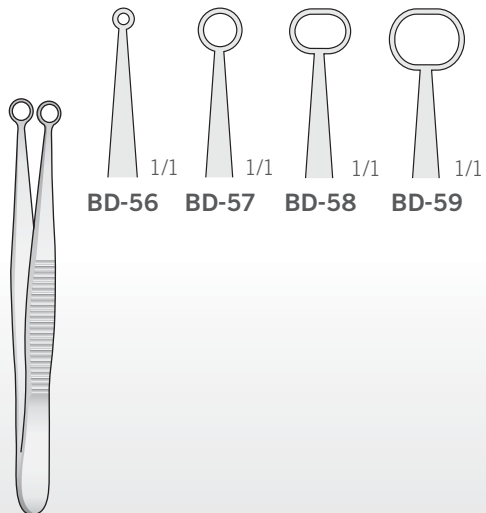

BD-56/BD-59
100 mm

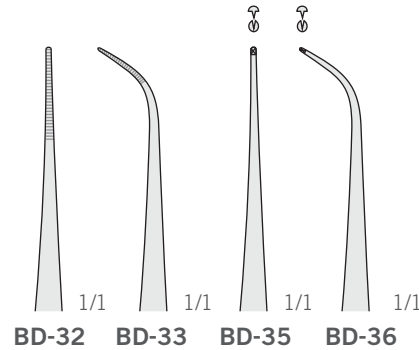

Iris Pinzetten
 Iris Forceps
 Pinze da iride
 Pinza para iris
 Pince à iris

BD-32/BD-36
100 mm

Chalazionpinzetten
 Chalazion Forceps
 Pinzette da calazio
 Pinzas para chalación
 Pincés à chalazion

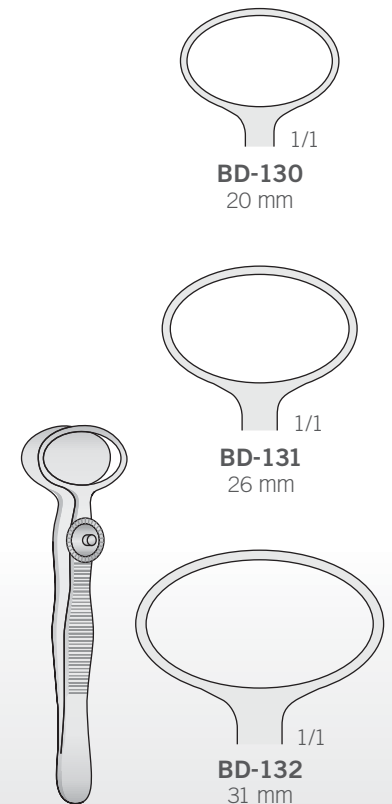

DESMARRES
BD-130/BD-132
90 mm



Fixierpinzetten
 Fixation forceps
 Pinze da Fissazione
 Pinzas de fijación
 Pincas à fixer

Mit Stop
 With Stop
 Con arresto
 Con parada
 Avec arrêt

Tying Forceps
 delicate 5 mm
 long platform
 for 7-0 to
 9-0 sutures

Tying & Utility
 Forceps standard
 7 mm long platform
 for sutures
 below 7-0

Suturing Forceps
 1x2 teeth
 of 0,3 mm set
 at 45° with delicate
 platform

Universal Suturing
 Forceps
 1x2 teeth of
 0,7 mm set at 45°
 with heavy platform



0,4 mm

0,25 mm

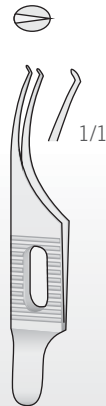
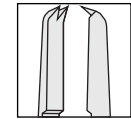
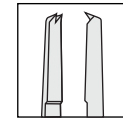
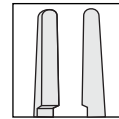
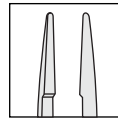

GRAEFE
BD-135
 110 mm

GRAEFE
BD-136
 110 mm

COLIBRI
NK-66
 75 mm

COLIBRI
NK-69
 80 mm

St. MARTIN
MF-200
 85 mm

PAUFIQUE
MF-201
 88 mm

St. MARTIN
MF-205
 85 mm

PAUFIQUE
MF-206
 88 mm



Traumatology - Orthopaedics

Traumatologie - Orthopädie
 Traumatologie - Orthopédie
 Traumatología - Ortopedia
 Traumatologia - Ortopedia

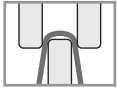

- Max Ø 0.7 mm (.028")
- 1.30 x 0.65 mm (.052" x .026")

Rostfrei
 Stainless Steel
 Acciaio Inox
 Acero Inoxidable
 Acier Inoxydable

Für weichen und harten Draht
 For soft and hard wire
 Per filo leggero e duro
 Para alambre blando y duro
 Pour fil léger e dur

Universalszange
 Universal Pliers
 Pinze universali
 Alicates universales
 Pinces universelles

Parallel-Flachzange mit Seitenschneider
 Flat-nose pliers parallel with lateral wire cutter
 Pinza a branche parallele con tronchese
 Alicates de ramas paralelas con corta-alambre lateral
 Caliper branches en parallèle avec des coupe

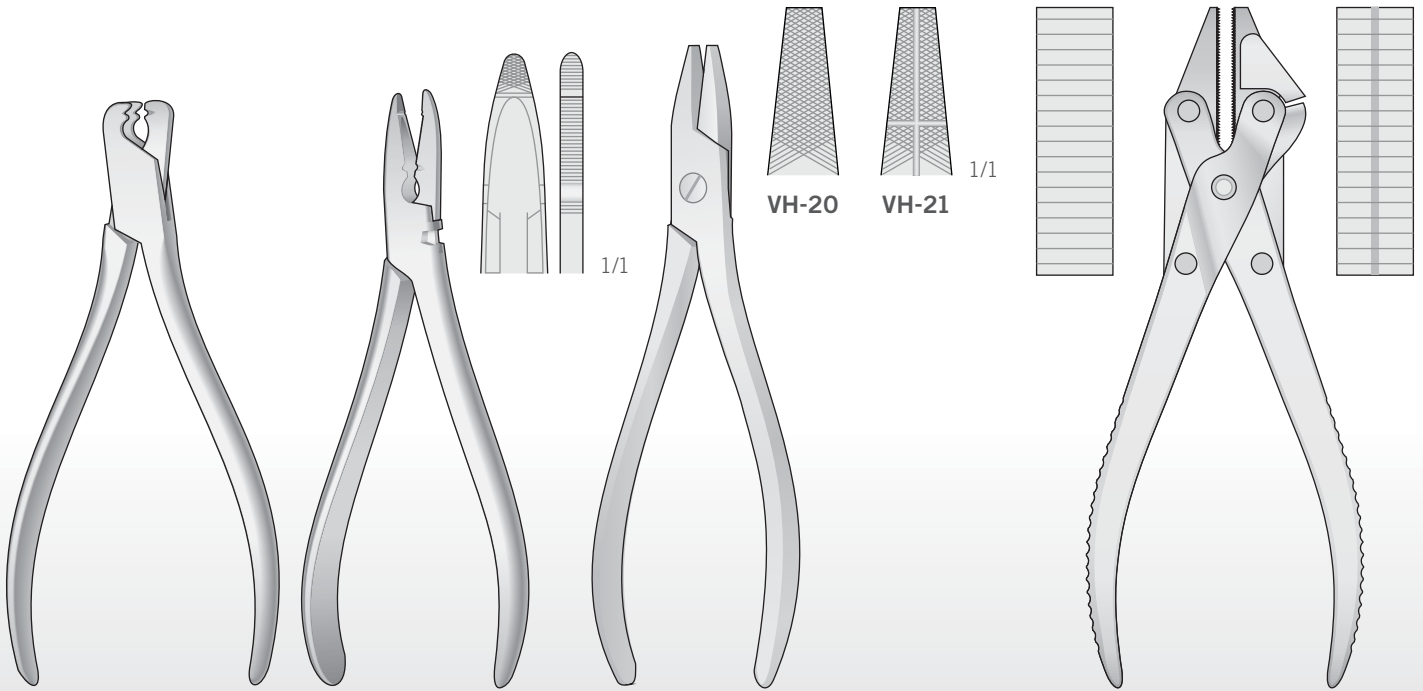

**ADERER
 DP-41**
 145 mm

**WALDSACHS
 DP-84**
 150 mm

VH-20/VH-21
 175 mm

LX-80
 185 mm

Traumatology - Orthopaedics

Traumatologie - Orthopédie

Traumatologie - Orthopédie

Traumatologia - Ortopedia

Traumatologia - Ortopedia

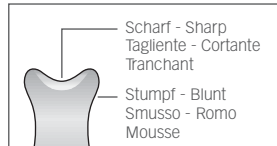
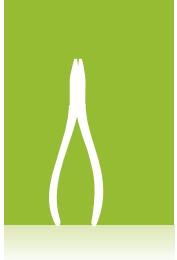

Für Lig. Femurkopf
For ligament femoral head
Per legamenti testa del femore
De la cabeza femoral del ligamento
Pour les ligaments tête femore

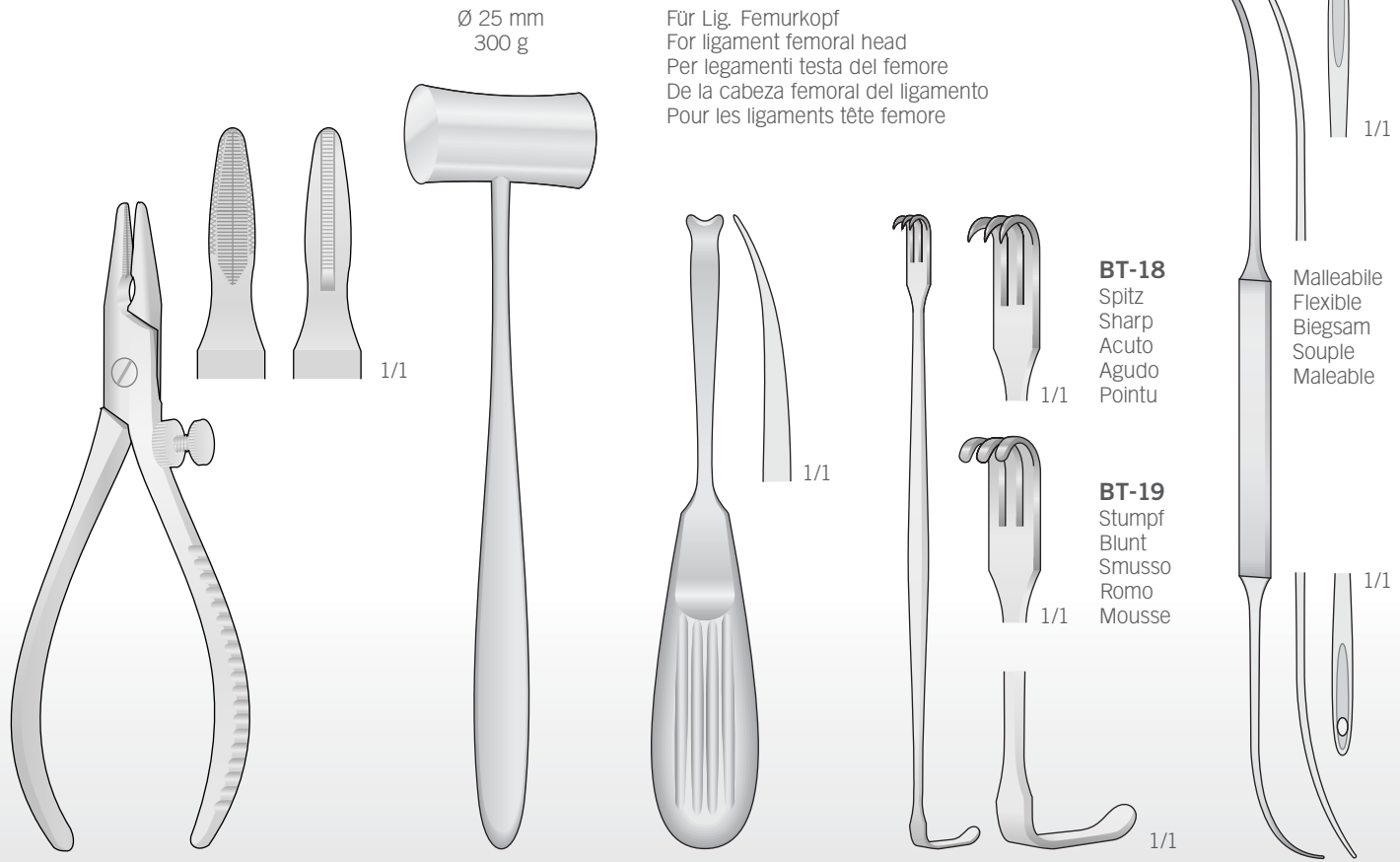

LX-131
180 mm

Ø 25 mm
300 g
**LUCAE
FL-10M**
190 mm

**ROSIN
DL-58**
160 mm

**SENN-MILLER
BT-18/BT-19**
160 mm

**SCHMIEDEN-DICK
BM-17**
320 mm

BT-18
Spitz
Sharp
Acuto
Agudo
Pointu

BT-19
Stumpf
Blunt
Smusso
Romo
Mousse

Malleabile
Flexible
Biegsam
Souple
Maleable



Traumatology - Orthopaedics

Traumatologie - Orthopädie

Traumatologie - Orthopédie

Traumatología - Ortopedia

Traumatologia - Ortopedia

BV-108

Spitz

Scharp

Acuto

Agudo

Pointu

BV-109

Stumpf

Blunt

Smusso

Romo

Mousse

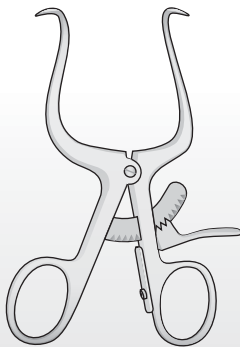

GELPI
BV-14
90 mm

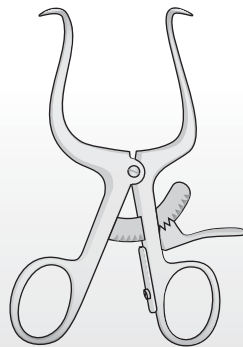
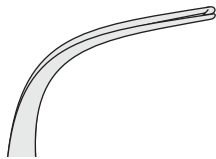

GELPI
BV-14M
90 mm

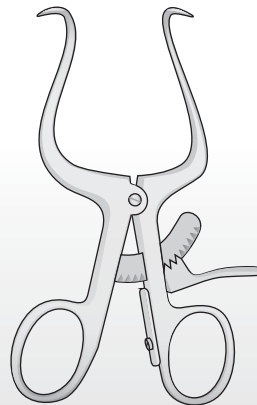

GELPI
BV-15
110 mm

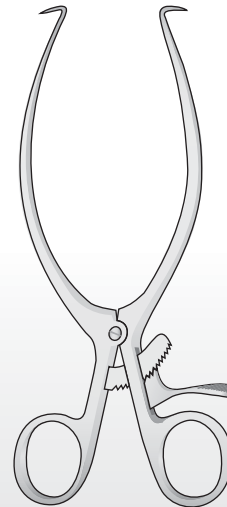

GELPI
BV-16
140 mm

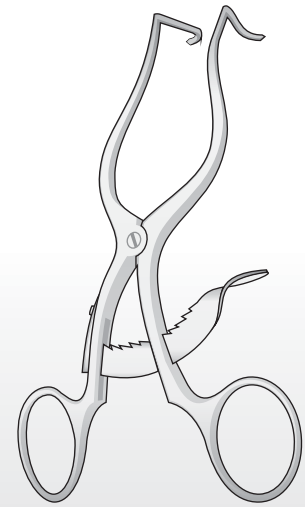

CLOWARD-CONTOUR
BV-108/BV-109
140 mm

Traumatology - Orthopaedics

Traumatologie - Orthopädie
 Traumatologie - Orthopédie
 Traumatologia - Ortopedia
 Traumatologia - Ortopedia

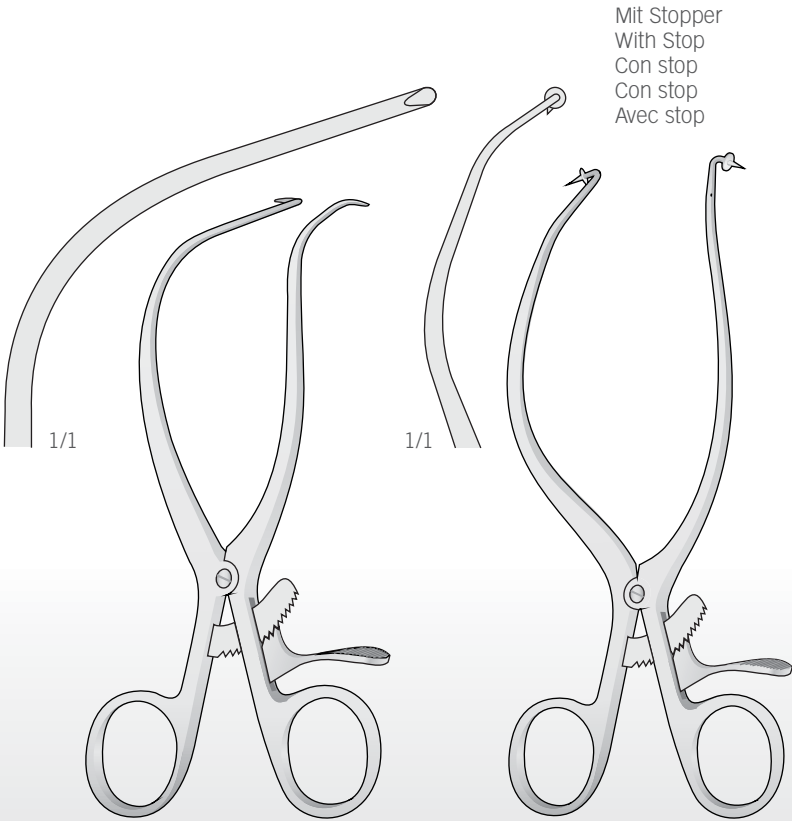

Mit Stopper
 With Stop
 Con stop
 Con stop
 Avec stop

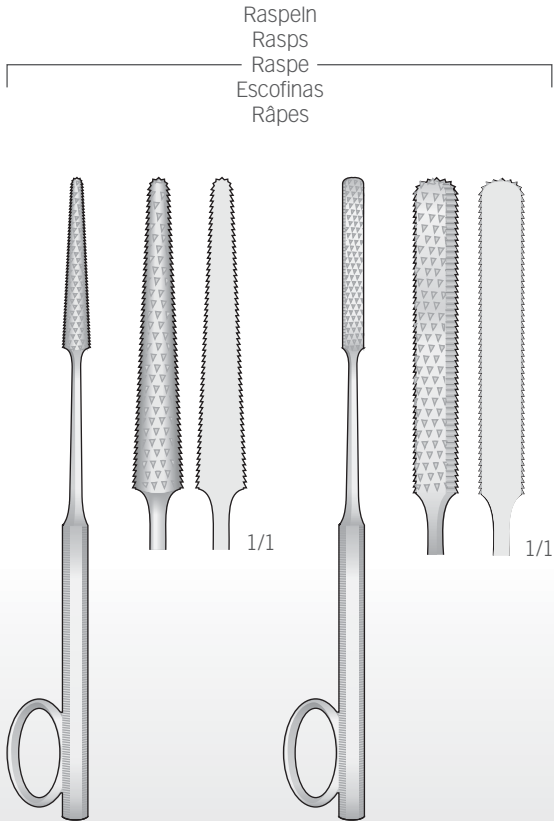

Raspeln
 Rasps
 Raspe
 Escofinas
 Râpes

GELPI-SELETZ
BV-11
 165 mm

GELPI-LOKTITE
BV-13
 190 mm

GOOD
FK-199
 160 mm

GALLAHER
FK-194
 160 mm

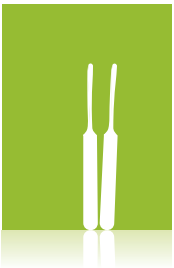

Traumatology - Orthopaedics

Traumatologie - Orthopädie
 Traumatologie - Orthopédie
 Traumatología - Ortopedia
 Traumatologia - Ortopedia

Raspatorien
 Periosteal Raspatories
 Periostotomi
 Legras periostótomos
 Rugines à périostomie

Knochensägen
 Bone saws
 Seghetti per osso
 Sierra para huesos
 Scies à os

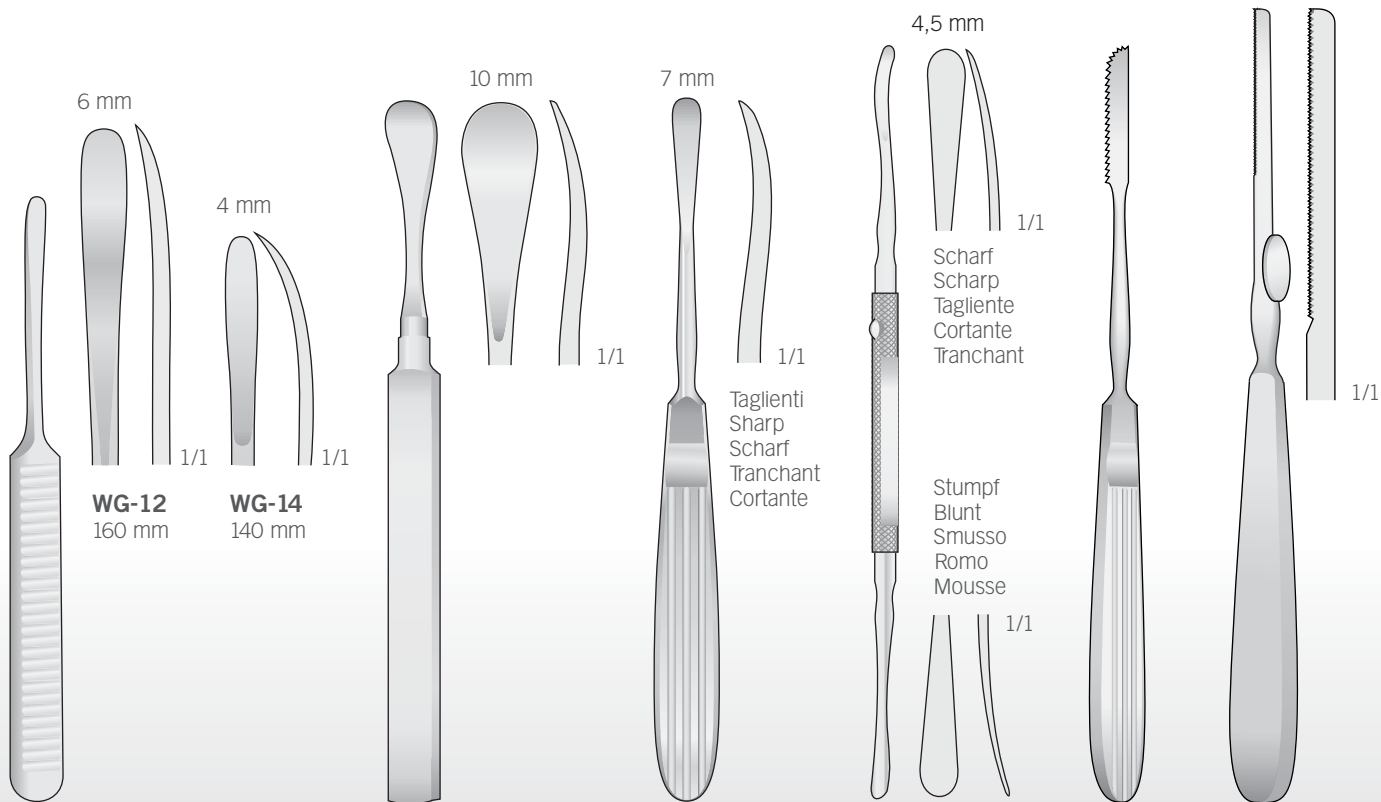

WILLIGER
WG-12/WG-14

HENAHAN
BT-05
 175 mm

OBWEGESER
DO-63
 175 mm

FREER
 180 mm

DO-267
 190 mm

LINDEMANN
FK-243
 200 mm

FL-90

Komplettsset mit - Set complete with
Set completo di - Set completo con
Set complet avec

Mit Ferrozellgriff 4 Klängen
With Ferrozell handle 4 Blades
Manico portalamo in ferrozell 4 Lame
Con mango de Ferrozell 4 Hojas
Avec poignée en Ferrozell 4 Lames

Traumatology - Orthopaedics

Traumatologie - Orthopédie
Traumatologie - Orthopédie
Traumatologia - Ortopedia
Traumatologia - Ortopedia

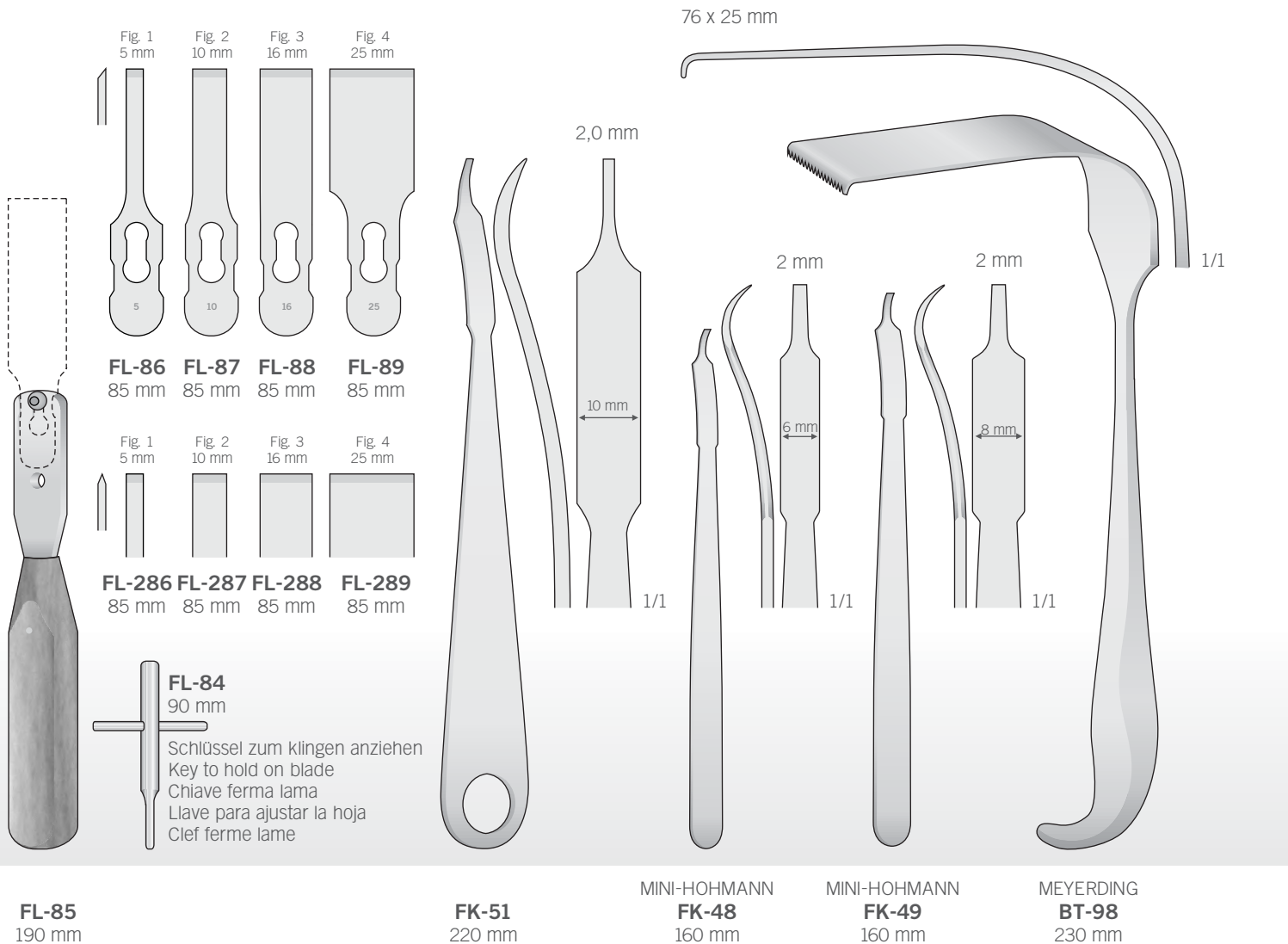



Traumatology - Orthopaedics

Traumatologie - Orthopädie
 Traumatologie - Orthopédie
 Traumatología - Ortopedia
 Traumatologia - Ortopedia

Von Hand zu spannen
 Tightened by hand
 Con chiusura a mano
 Cerrado a mano
 Serré à la main

Inox
 Spannbereich
 0 - 3 mm

Inox
 Spannbereich
 0,8 - 6 mm

Inox
 ORIGINAL JACOBS
 Ø 10 mm

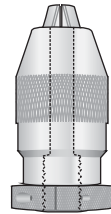

LS-222

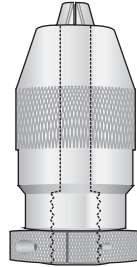

LS-224

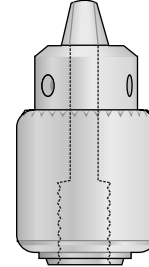

LS-236
 50 mm

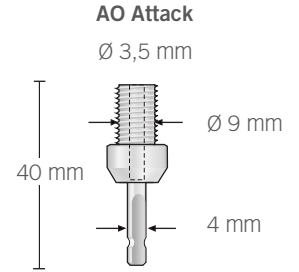

LS-227
 40 mm

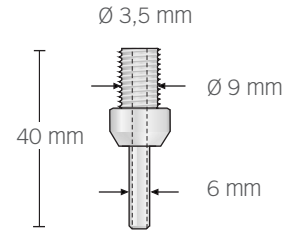

LS-228
 40 mm

Canulato

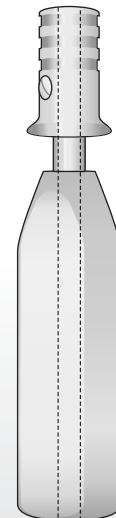

LS-320
 145 mm

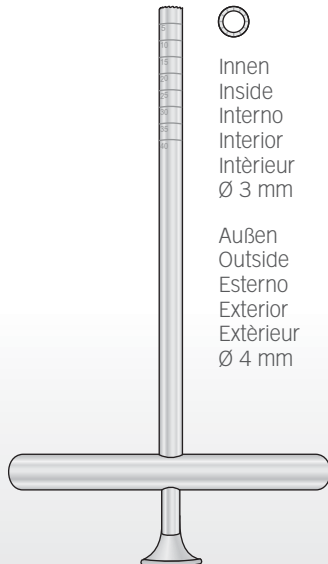

FK-92
 170 mm

Innen
 Inside
 Interno
 Interior
 Intérieur
 Ø 3 mm

Außen
 Outside
 Esterno
 Exterior
 Extérieur
 Ø 4 mm

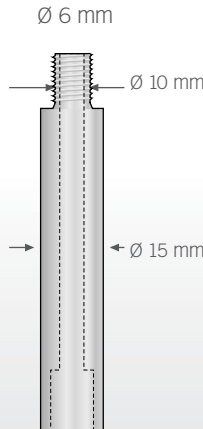

Ø 10 mm
LS-237
 90 mm

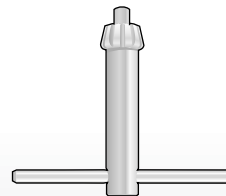

LS-241
 52 mm

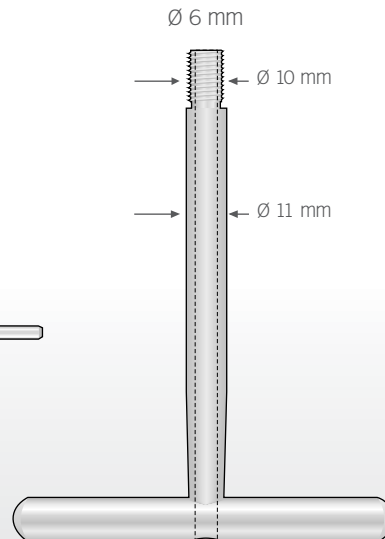

Ø 6 mm
LS-238
 130 mm

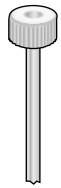

Steckbohrbüchsen
 Insert-drill
 Manicotto dentato - Centrapunte
 Guía de perforación
 Guide de perçage

Ø Außen	Ø Für Bohrer
Ø Outside	Ø For drills
Ø Esterno	Ø Per punte
Ø Exterior	Ø Para brocas
Ø Extérieure	Ø Pour Mèches

Cod. Art.

LS-114	3,5 mm	2 mm
LS-115	3,5 mm	2,7 mm

LS-95

Guide Point for bone

Komplett mit
 Complete with
 Completo con
 Completo con
 Complet avec

LS-94
 LS-96
 LS-97
 LS-98

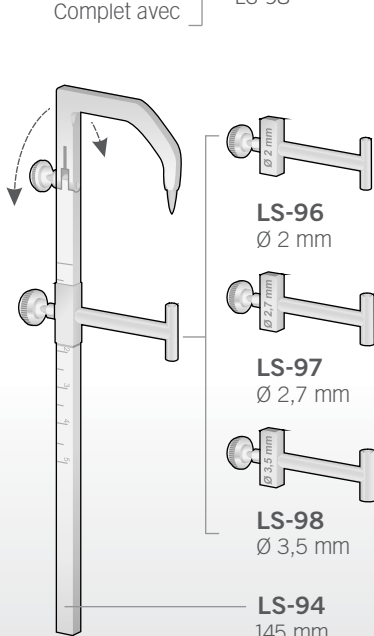

Ø Int. 1,6 mm
 Ø Est. 2,6 mm

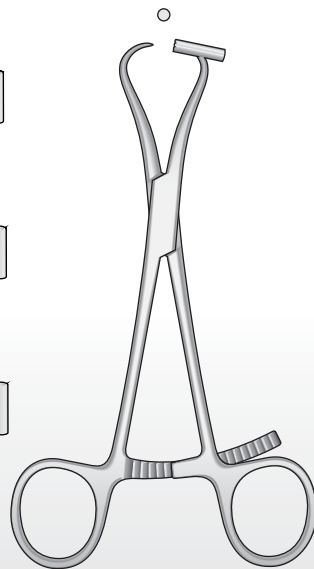

FO-242
 140 mm

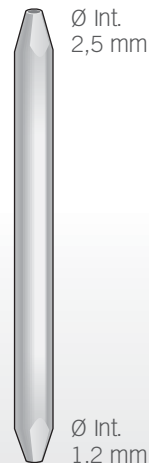

LS-100
 120 mm

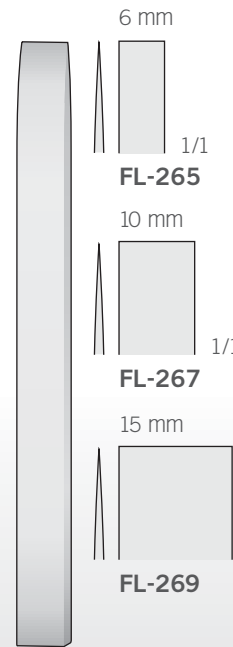

MINI-LAMBOTTE
FL-265
 170 mm

Zange Cerclage
 Cerclage forceps
 Pize per cerchiaggi
 Pinza para Cerclaje
 Pincés pour cerclage

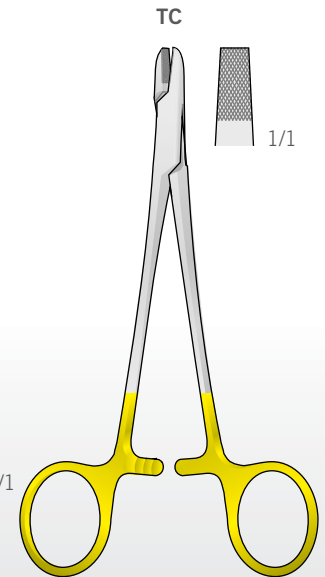

PH-58
 150 mm

LS-95



Traumatology - Orthopaedics

Traumatologie - Orthopädie
 Traumatologie - Orthopédie
 Traumatología - Ortopedia
 Traumatologia - Ortopedia

Löffel
 Spoons
 Cucchiali
 Cucharillas
 Cuillère

4-Hubs
 4 Hubs
 4 Snodi
 4 Centros
 4 Pôles

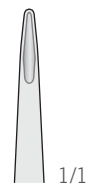

FO-23

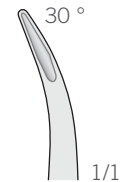

FO-22

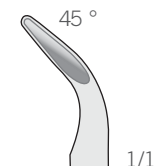

FO-220

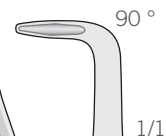

FO-24

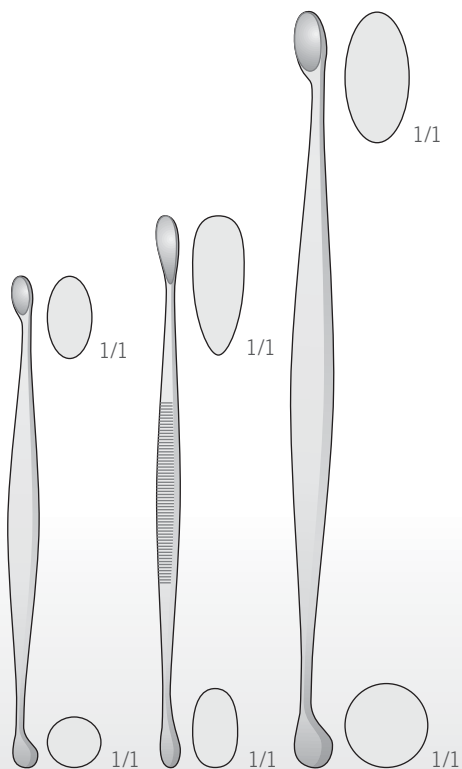

FK-177
130 mm

VOLKMANN
FK-72
145 mm

FK-178
200 mm

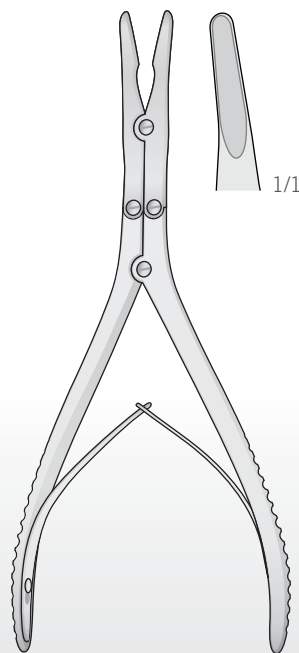

BEYER
FO-20
180 mm

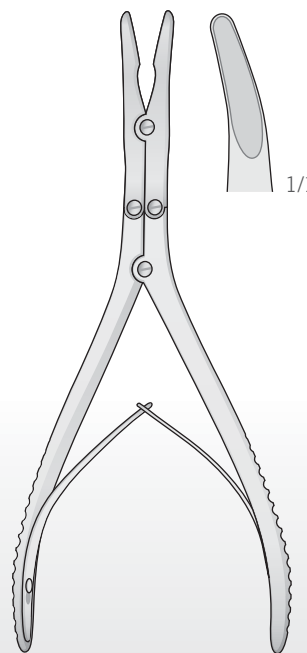

ZAUFAL-JANSEN
FO-34
180 mm

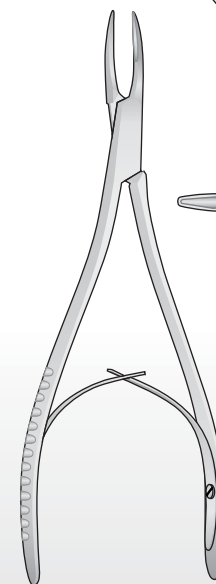

MINI-FRIEDMANN
FO-22/FO-220
150 mm

Traumatology - Orthopaedics

Traumatologie - Orthopädie
 Traumatologie - Orthopédie
 Traumatologia - Ortopedia
 Traumatologia - Ortopedia

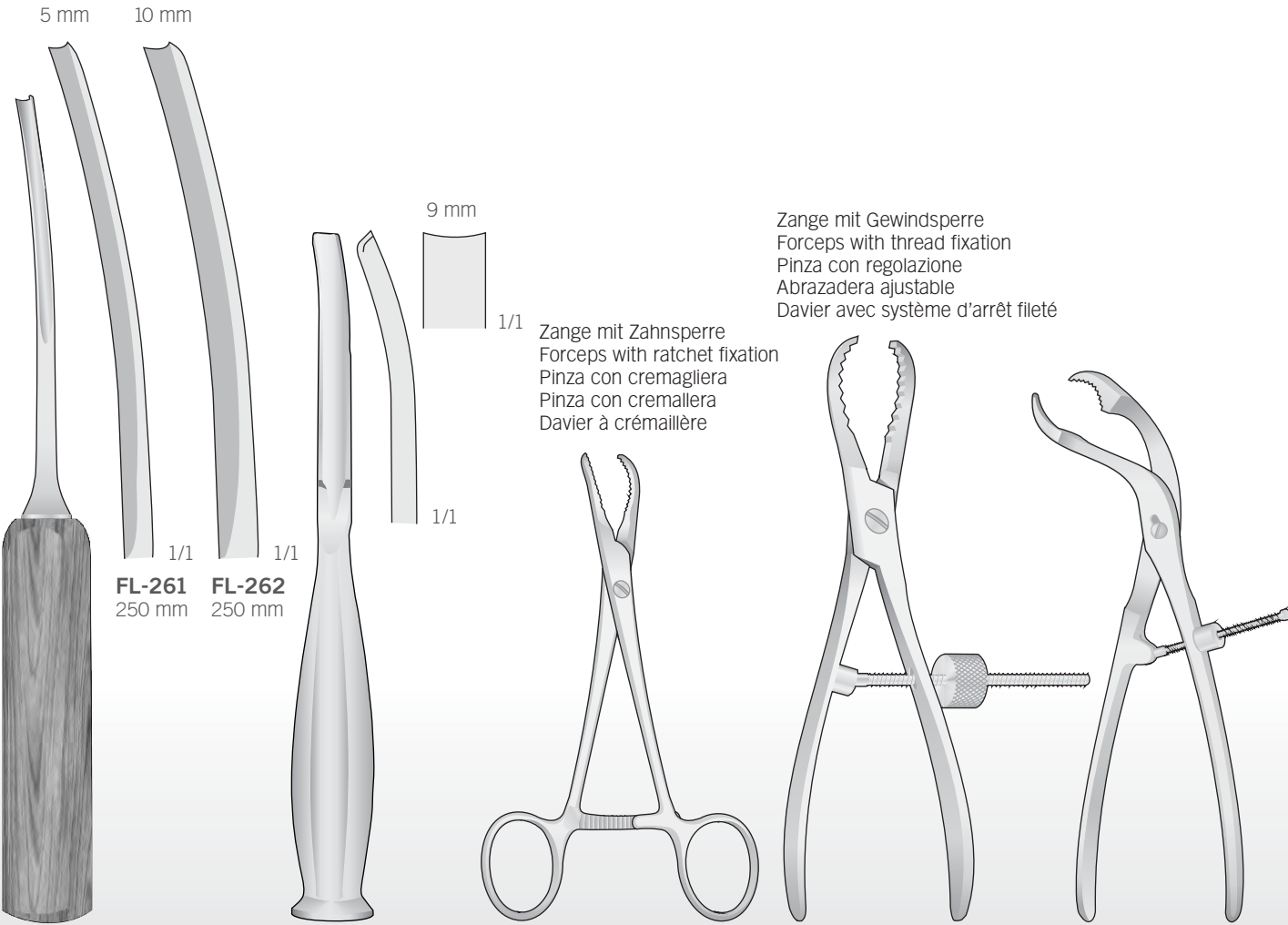

LEXER
FL-261
 250 mm

SMITH-PETERSEN
FL-359
 200 mm

FO-47
 140 mm

FO-48
 170 mm

FO-71
 150 mm



Traumatology - Orthopaedics

Traumatologie - Orthopädie
Traumatologie - Orthopédie
Traumatología - Ortopedia
Traumatologia - Ortopedia



FO-62
230 mm

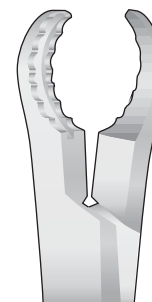

FO-82
250 mm

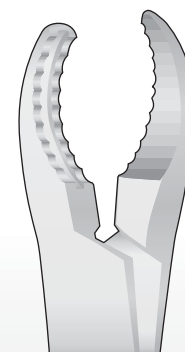

FO-105
280 mm

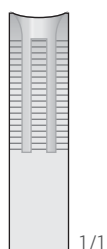

1/1

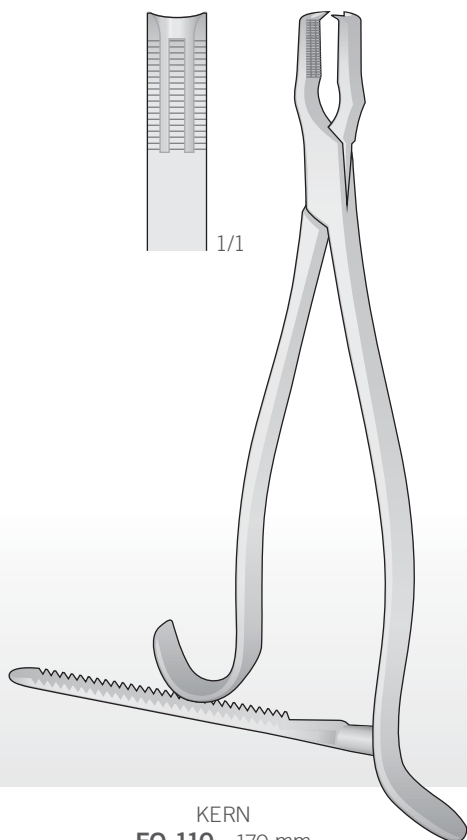

KERN
FO-110 170 mm
FO-112 220 mm

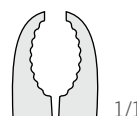

1/1

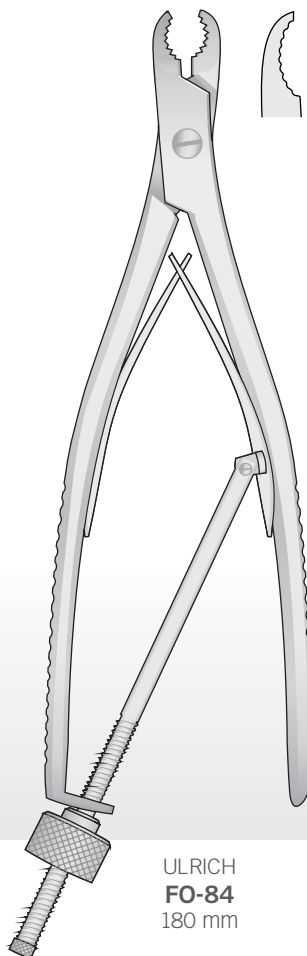

ULRICH
FO-84
180 mm

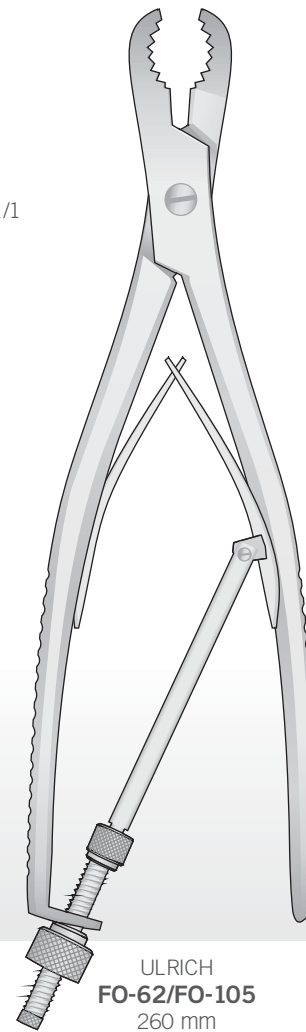

ULRICH
FO-62/FO-105
260 mm

Traumatology - Orthopaedics

Traumatologie - Orthopädie
 Traumatologie - Orthopédie
 Traumatologia - Ortopedia
 Traumatologia - Ortopedia

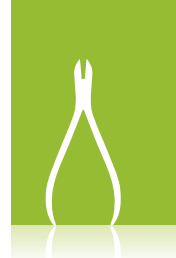

Für weichen Draht Ø 5 mm
 Für harten Draht Ø 4,5 mm
 For soft wire Ø 5 mm
 For hard wire Ø 4,5 mm
 Per filo leggero Ø 5 mm
 Per filo duro Ø 4,5 mm
 Para alambre blando Ø 5 mm
 Para alambre duro Ø 4,5 mm
 Pour fil léger Ø 5 mm
 Pour fil dur Ø 4,5 mm

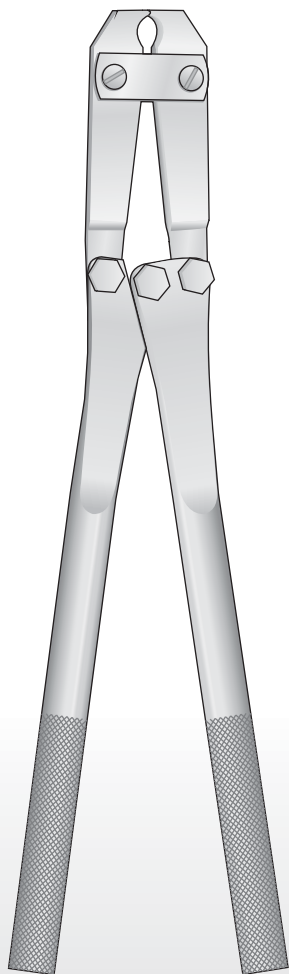

LX-107
375 mm

Für weichen draht Ø 2,5 mm
 Für harten draht Ø 2 mm
 For soft wire Ø 2,5 mm
 For hard wire Ø 2 mm
 Per filo leggero Ø 2,5 mm
 Per filo duro Ø 2 mm
 Para alambre blando Ø 2,5 mm
 Para alambre duro Ø 2 mm
 Pour fil léger Ø 2,5 mm
 Pour fil dur Ø 2 mm

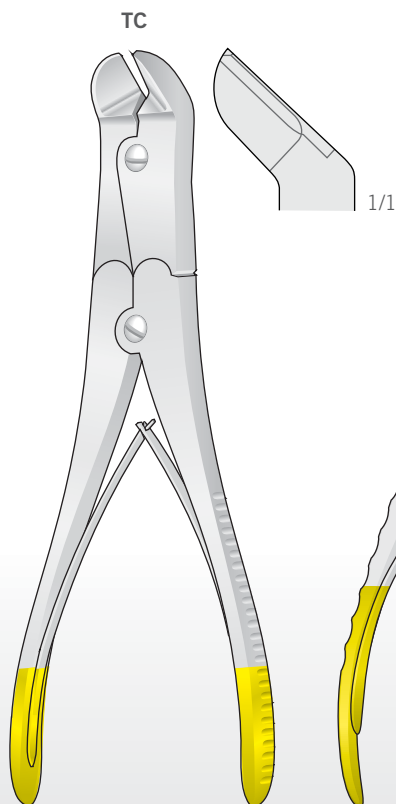

LX-105
230 mm

Für weichen draht Ø 3,5 mm
 Für harten draht Ø 2,5 mm
 For soft wire Ø 3,5 mm
 For hard wire Ø 2,5 mm
 Per filo leggero Ø 3,5 mm
 Per filo duro Ø 2,5 mm
 Para alambre blando Ø 3,5 mm
 Para alambre duro Ø 2,5 mm
 Pour fil léger Ø 3,5 mm
 Pour fil dur Ø 2,5 mm

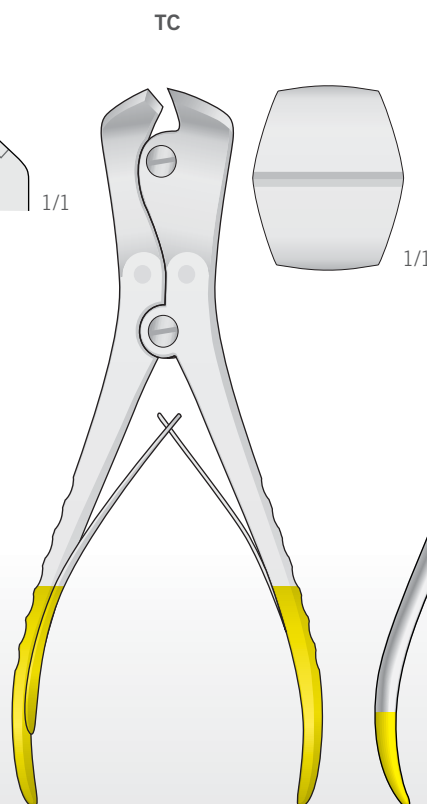

LX-104
215 mm

○ Max Ø 1.0 mm (.040")

Seitenschneider
 Side Cutters
 Taglio laterale
 De corte lateral
 Coupante latérale

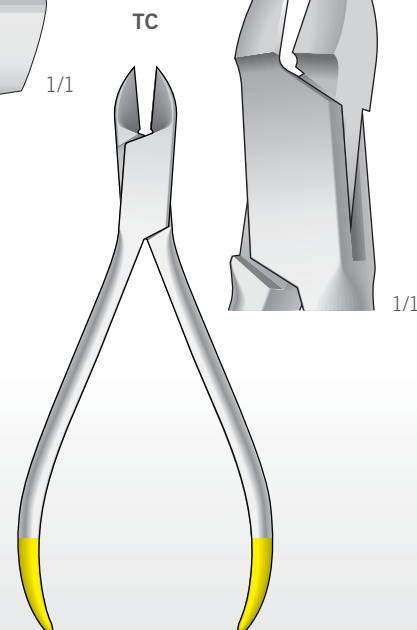

LX-96TC
150 mm



Traumatology - Orthopaedics

Traumatologie - Orthopädie
Traumatologie - Orthopédie
Traumatología - Ortopedia
Traumatologia - Ortopedia

Lange Rack
Long Rack
Cremagliera lunga
Cremallera larga
Crémaillère longue

Lange Schraube
Long Screw
Vite lunga
Tornillo largo
Vis longue

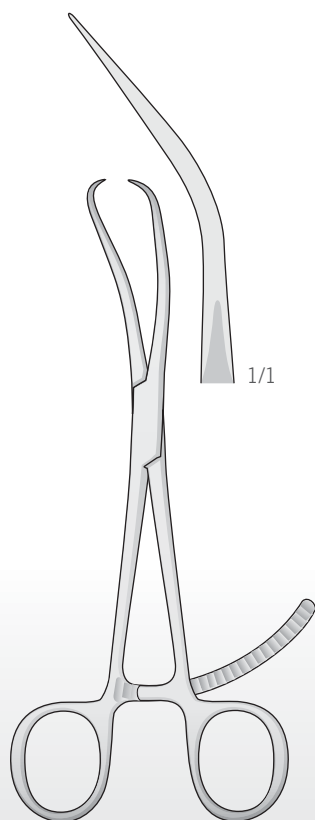

REILL
FO-64L
170 mm

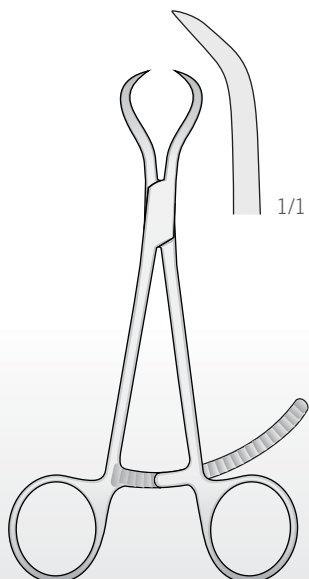

FO-66L
135 mm

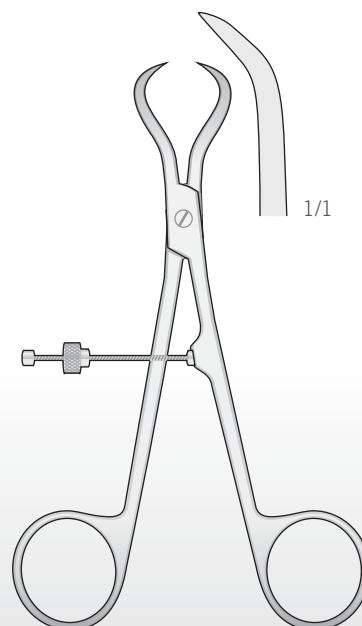

FO-79
140 mm

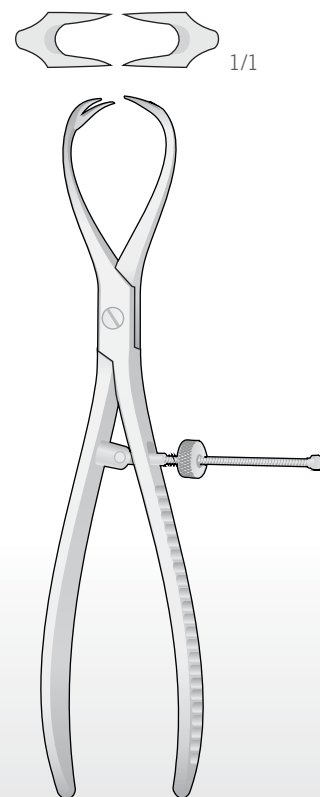

PATELLA
FO-46L
185 mm



Mit Schraubverschluss
With screw
Con vite di fissaggio
Con tornillo
Avec vis

ENT - Otolaryngology
HNO - Heilkunde
ORL - Oto-rhino-laryngologie
ORL - Otorrinolaringologia
ORL - Otorinolaringoiatria

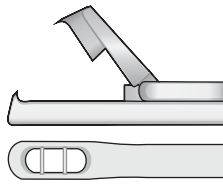

1/1

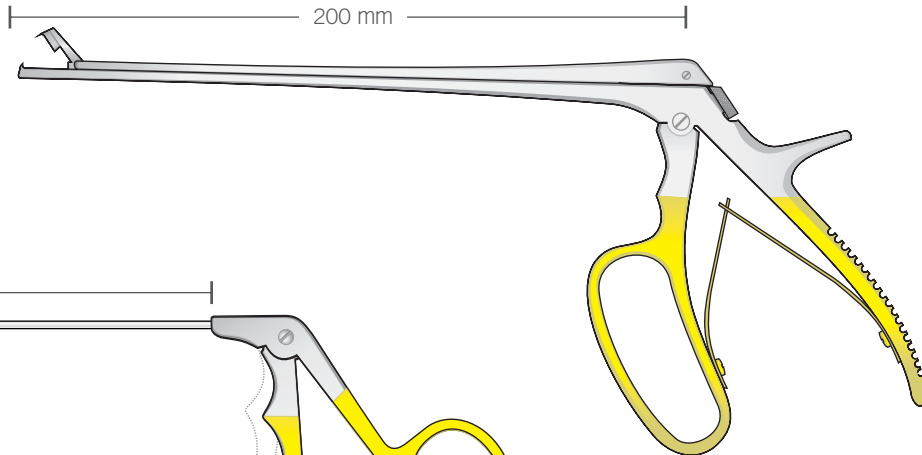

200 mm

**TISCHLER-MORGAN
FF-59**

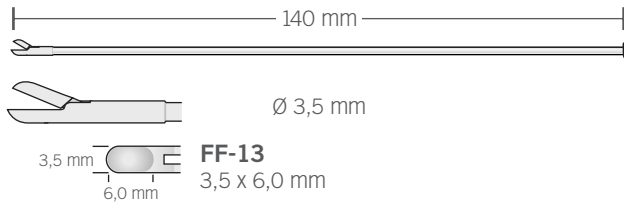

140 mm

Ø 3,5 mm

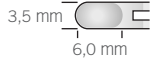

FF-13
3,5 x 6,0 mm

FF-13

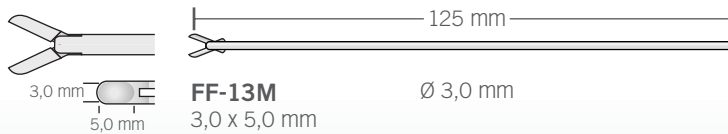

125 mm

Ø 3,0 mm



FF-13M
3,0 x 5,0 mm

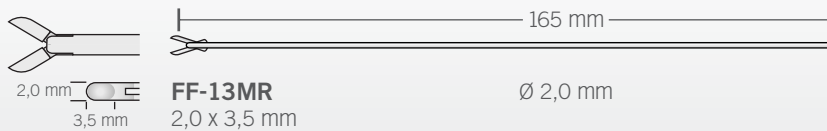

165 mm

Ø 2,0 mm



FF-13MR
2,0 x 3,5 mm

FF-13M/FF-13MR



Neurosurgery
 Neurochirurgie
 Neurochirurgie
 Neurocirugia
 Neurochirurgia

CASPAR
FF-200M
 Distraktor Lang komplett
 Distractor Long complete
 Distrattore modificato completo

FF-201M
 1 Distraktor Lang
 1 Distractor Long only

FF-202
 1 Bohrbüchse
 1 Drilling Guide

FF-203
 1 Spezialbohrer
 1 Special Drill

FF-205
 2 Distraktionsschrauben
 2 Distraction Screws

FF-206
 1 Schraubendreher
 1 Screw Driver

Spezialbohrer
 Special Drill
 Ø 1,7 mm

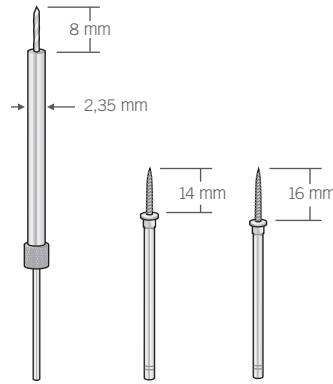

CASPAR
FF-203
 145 mm

CASPAR
FF-204
 70 mm

CASPAR
FF-205
 70 mm

Schraubendreher
 Screw Driver

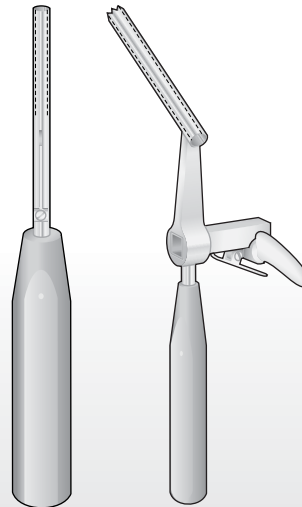

CASPAR
FF-206
 200 mm

FF-202
 Bohrbüchse
 Drilling Guide only
 Guida punte solo

Dissettoire per
 Neurochirurgia

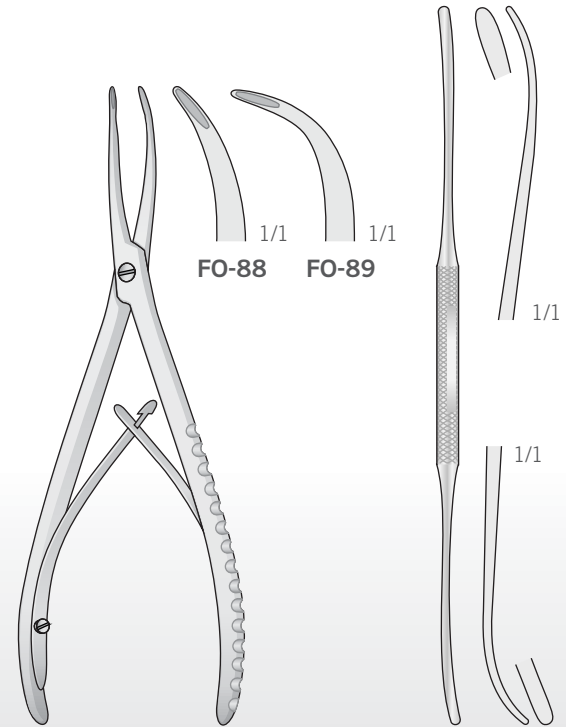

FO-88

FO-89

1/1

1/1

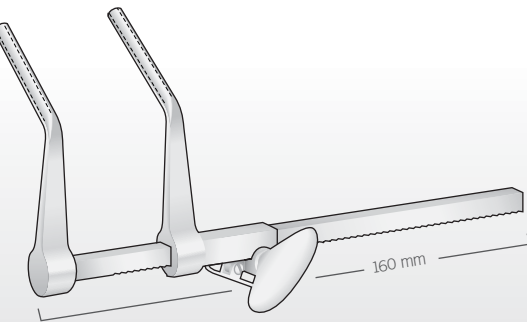

CASPAR
FF-201M
 Distraktor Lang
 Distractor Long only
 Distrattore modificato solo

STELLBRINK
FO-88/FO-89
 170 mm

OLIVECRONA
KO-47
 180mm

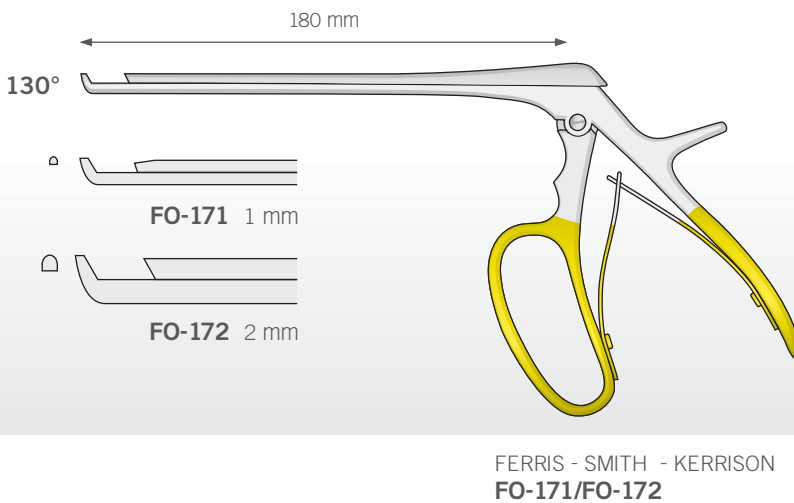
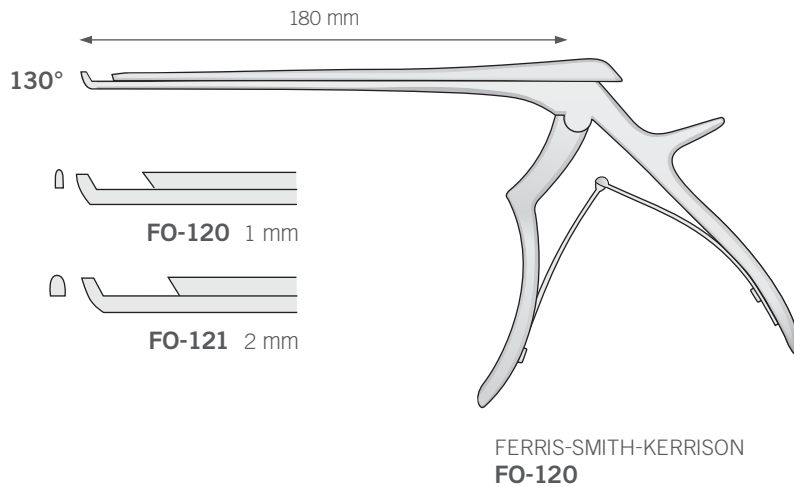

Femur-Wundspreizer
 Femur Retractor
 Divaricatore femorale

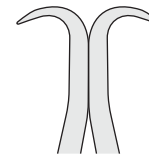

Femur-Wundspreizer
 Femur Retractor
 Divaricatore femorale

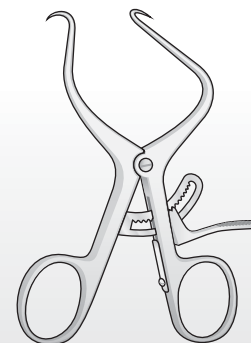
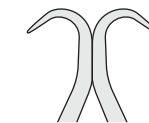

DE BAKEY
BV-315
 100 mm

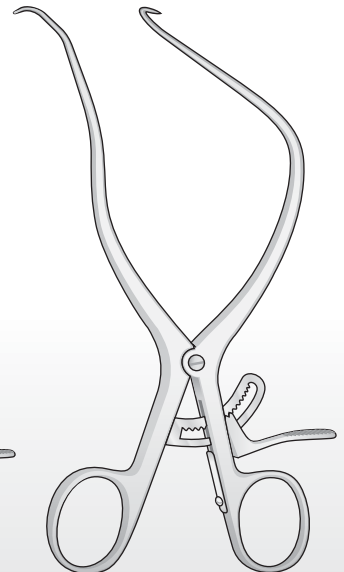

DE BAKEY
BV-316
 170 mm

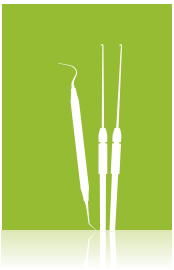

Neurosurgery
 Neurochirurgie
 Neurochirurgie
 Neurocirugia
 Neurochirurgia

Palpatorischen
 Palpatory
 Palpatori
 Palpación
 Palpatoire

Schlingen
 Anses
 Anse
 Ansas
 Boucles

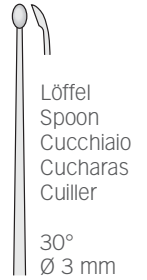

AS-16
 225 mm

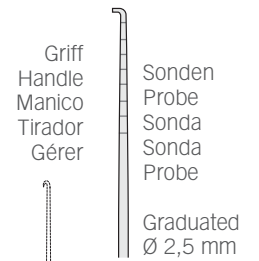

AS-19
 220 mm

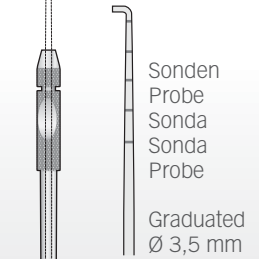

AS-20
 220 mm

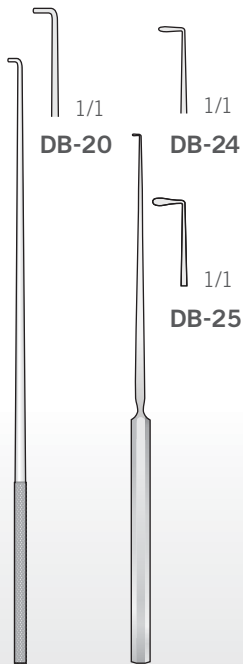

DAY
DB-20
 160 mm

LUCAE
DB-24/DB-25
 140 mm

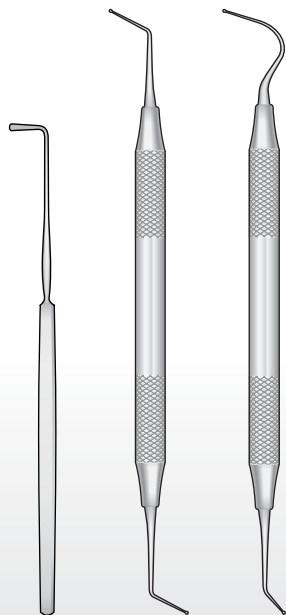

GRAEFE
NK-245
 130 mm

713-101 713-102 717-100

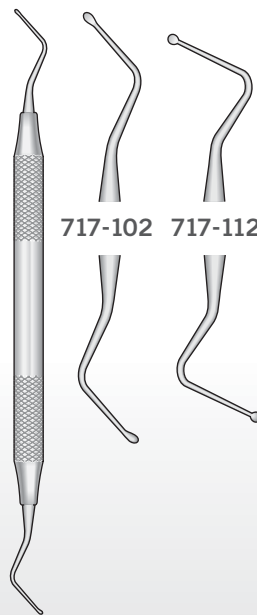

BILLEAU
DB-30
 160 mm

SNELLEN
NK-45/NK-46
 135 mm

AS-10
 125 mm

Cleaning, Maintenance and Sterilization of Surgical Instruments

Reinigung, Wartung und Sterilisation von chirurgischen Instrumenten
 Nettoyage, entretien et stérilisation d'instruments chirurgicaux
 Limpieza, mantenimiento y esterilización de instrumentos quirúrgicos
 Pulizia, manutenzione e sterilizzazione degli strumenti chirurgici



SHARPEN - LUBRICATE

India # 6
Medium grit 100 x 45 mm
4 x 1.8 in

Arkansas # 6A
Fine texture



DB-3 DB-6A

Wedge Stones

They combine flat surfaces with rounded edges to manually sharpen internal parts (straight and curved edges) of curettes and scalers.

Arkansas: for routine sharpening and finishing.

India: for sharpening of excessively dull instruments or those requiring recontouring.



DB-4

Rectangular Stone

A flat and rectangular stone used to sharpen all cutting parts of surgical instruments.

Necessary in routine sharpening and finishing of edge and toe of an instrument.

Arkansas: a natural stone extracted from the Arkansas mountains.

India: a synthetic stone quarried from the finest Ozark novaculite-silicon quartz-deposits.



DB-299

Conical Stone

A cone-shaped and cylindrical stone used to manually sharpen internal parts of curettes, scalers, gouges, rongeurs, etc. (in areas that otherwise cannot be reached).



DB-96

Flat Stone

A flat and rectangular stone used to sharpen all cutting parts of scissors, osteotomes, curettes, etc. (whenever necessary).



DB-0L

Lubricating and Sharpening Oil

A non-coloured oil, which is an indispensable complement for lubricating and manual sharpening of surgical instruments. To activate the abrasive properties of Arkansas or India stones and to reduce the possibility of overheating the instruments during sharpening. It should be applied on all hinges or all other parts which are subject to movement or friction. Its use facilitates elimination of any residue present within the instrument hinges. Used to ensure perfect function and fluid movement of all surgical instruments. Must ALWAYS be used during all sharpening operations.

Oil
30 cc
1 fl oz

Ceramic
76 x 25 x 6 mm
3 x 1 x 1/4 in

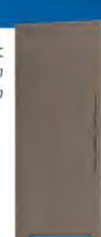

DB-71

Ceramic Stone

Ceramic stones are valued for their durability and the very keen edge they give in the finer grits. Will never pit or groove. Used for routine sharpening procedures. Autoclave safe.

Ceramic: use only dry. (Do not use with oil, water or lubricants)

RINSE - CLEAN

CLEANLACT | Detergent Milk

Special milk for surgical instruments. Anticorrosive, bacteriostatic and lubricating action on all surgical instruments. Extends your instrument's lifetime. It guarantees perfect maintenance by eliminating eventual stains, halos and browning due to sterilization, disinfection and washing with tap water.

Must be applied periodically, diluted or concentrated. (see special instructions on packaging)



DB-50M DB-1L
500 cc 1000 cc
17 oz 34 oz

Brushes | Autoclavables

Special brushes to clean surgical instruments.

Used to remove eventual residue, organic or not, from all surgical instruments, in particular in angled, hinged and knurled parts, without damaging instrument surface.

Must be applied every time, for regular cleaning of all instrumentation and in the event that an instrument is exposed for an extended period to air before being immersed in the cleaning solution.



DB-11 DB-12
155 mm 175 mm
6 in 7 in

Special Rubbers for metal

50 x 40 x 20 mm / 2 x 1.6 x 0.8 in

An abrasive eraser specially designed for surgical instruments to remove stains, halos or persistent burnishing from all surgical instruments without damaging the instrument surface.

Necessary when routine cleaning does not remove all stains.



DB-08 DB-07
Coarse Fine

STERILIZATION

Stainless Steel Cassettes

Silicone racks - Autoclavable

- BS-905^A 5 instruments BS-59^E
- BS-910^A 10 instruments BS-60^F
- BS-915^C 15 instruments
- BS-920^D 20 instruments BS-61^G

1.2 x 8 x (3^A)(6^B)(11^C)(12^D) in
 30 x 200 x (75^A)(150^B)(275^C)(300^D) mm
 Available only in North America

1.4 x 7 x (3^F)(5.7^F)(11.5^G) in
 35 x 185 x (75^F)(145^F)(290^G) mm

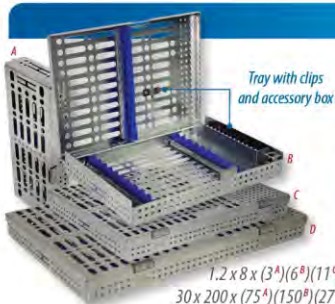

TESTING

Teflon Testing Stick

Ø 8 x 100 mm / Ø 0.3 x 3.5 in

A hard plastic stick used to test the blade of an instrument to determine the sharpness of an instrument.

Must be used ALWAYS. If the blade of the instrument runs smoothly over the plastic stick, then it is blunt. A sharp instrument will grab into the stick and removes small fragments of the plastic.



DB-15

CODING

Silicone Code Rings

- DB-941 120 Items
- DB-942 175 Items





Optimum maintenance cycle for surgical instruments

Optimale Wartungszyklus für Chirurgische Instrumente

Cycle optimal d'entretien pour instruments chirurgicaux

Ciclo óptimo de mantenimiento para instrumentos quirúrgicos

Ciclo ottimale di manutenzione per strumenti chirurgici

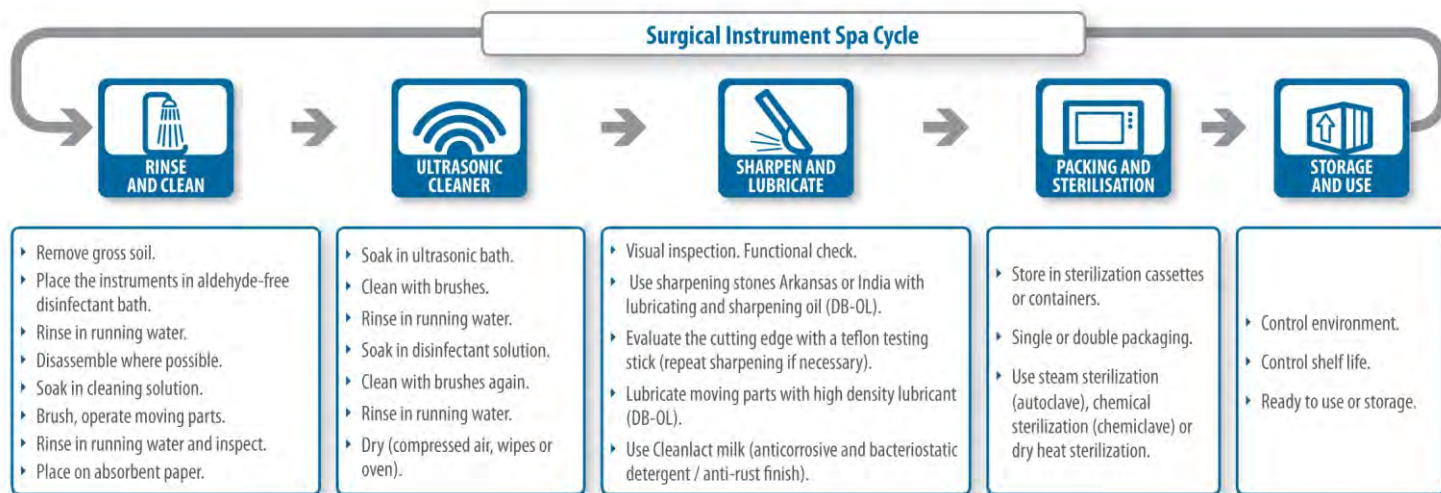

Alphanumerical index
 Nummernverzeichnis
 Index alphanumerique
 Indice alfanumérico
 Indice alfanumerico



1	24	BD-157	10	CU-1/2	25	EA-10	12	FK-72	40	FM-318	8	LB-365	29	NK-47	29	PH-107	17
30	24	BD-250	9	CU-3/4	25	EA-11	12	FK-92	38	FM-319	8	LB-367	29	NK-48	29	PH-122	16
49	24	BD-274	10	DA-01	22	EA-13	12	FK-177	40	FM-328	8	LK-4	3	NK-66	31	PH-127	16
56	24	BD-371	9	DA-02	22	EA-14	12	FK-178	40	FM-337	7	LS-94	39	NK-69	31	PO-34	18
713-101	48	BEIN-2	23	DB-07	49	EA-50	12	FK-194	35	FM-343	6	LS-95	39	NK-80	27	PO-35	18
713-102	48	BEIN-2Z	23	DB-08	49	EA-51	12	FK-199	35	FO-20	40	LS-96	39	NK-82	27	PO-36	18
715-102	26	BEIN-3	23	DB-1L	49	EA-53	12	FK-243	36	FO-22	40	LS-97	39	NK-84	27	PO-50	18
715-103	26	BEIN-4	23	DB-3	49	EA-54	12	FL-10M	33	FO-23	40	LS-98	39	NK-86	27	PO-51	18
717-100	48	BF-38	11	DB-4	49	FB-16	13	FL-84	37	FO-24	40	LS-100	39	NK-245	48	PO-52	18
717-102	48	BF-40	11	DB-6A	49	FB-255	28	FL-85	37	FO-34	40	LS-114	39	NK-274	29	PO-66	18
717-112	48	BF-41	11	DB-10M	49	FB-256	13	FL-86	37	FO-46L	44	LS-115	39	OL-07	15	PO-86	18
718-277	25	BF-42	11	DB-11	49	FD-11	27	FL-87	37	FO-47	41	LS-222	38	OL-08	15	PO-95	18
718-M23	25	BF-44	11	DB-12	49	FD-41	27	FL-88	37	FO-48	41	LS-224	38	OL-22	15	PO-98	18
718-M23A	25	BF-48	11	DB-15	49	FD-42	27	FL-89	37	FO-62	42	LS-227	38	OL-31	15	PO-100	18
718-M23B	25	BF-64	5	DB-20	48	FD-64	27	FL-152	15	FO-64L	44	LS-228	38	OL-32	15	R-2	26
719-111	25	BM-01	16	DB-24	48	FD-65	27	FL-261	41	FO-66L	44	LS-236	38	OL-33	15	R-3	26
AS-10	48	BM-02	16	DB-25	48	FD-66	27	FL-262	41	FO-71	41	LS-237	38	OL-36	15	RH-4	22
AS-16	48	BM-03	16	DB-30	48	FD-67	27	FL-265	39	FO-79	44	LS-238	38	OL-40	15	SC-1	5
AS-19	48	BM-04	16	DB-31	48	FD-68	27	FL-267	39	FO-82	42	LS-241	38	OL-50	29	SC-9	5
AS-20	48	BM-17	33	DB-32	48	FD-105	28	FL-269	39	FO-84	42	LS-320	38	OM-09	29	SC-13	5
BB-46	29	BN-502	19	DB-50M	49	FD-106	28	FL-286	37	FO-88	46	LX-80	32	OR-12	27	SD-M	21
BD-10	10	BS-59	49	DB-96	49	FD-107	28	FL-287	37	FO-89	46	LX-96TC	43	OR-17	27	SM-11	22
BD-16	10	BS-60	49	DB-114	14	FD-108	28	FL-288	37	FO-105	42	LX-98	21	P-24	11	SM-13	22
BD-18	10	BS-61	49	DB-120	14	FD-109	28	FL-289	37	FO-110	42	LX-104	43	P-34	11	US DL-401	20
BD-27	10	BT-05	36	DB-121	14	FD-110	28	FL-359	41	FO-112	42	LX-105	43	P-50	13	US DL-402	20
BD-28	10	BT-18	33	DB-122	14	FF-13	45	FM-1	4	FO-120	47	LX-107	43	P-52	13	US DL-403	20
BD-30	9	BT-19	33	DB-299	49	FF-13M	45	FM-2	4	FO-121	47	LX-131	33	P-91	11	US DL-500	20
BD-31	9	BT-98	37	DB-940	19	FF-13MR	45	FM-3	4	FO-171	47	MA-2	22	P-92	11	VF-102	15
BD-32	30	BV-04	27	DB-941	19	FF-59	45	FM-3F	4	FO-172	47	MC-11	25	P-100	13	VF-102M	15
BD-33	30	BV-06	27	DB-942	19	FF-200M	46	FM-4	4	FO-220	40	MC-12	25	P-120	28	VF-120	20
BD-35	30	BV-11	35	DB-OL	49	FF-201M	46	FM-4F	4	FO-242	39	MC-13	25	P-121	28	VF-121	20
BD-36	30	BV-13	35	DB-OLR	49	FF-202	46	FM-12	3	FREEE	21, 36	MF-200	31	P-193	13	VF-122	20
BD-42	10	BV-14	34	DL-05	22	FF-203	46	FM-66	6	GF-09	14	MF-201	31	P-266	11	VF-126	20
BD-56	30	BV-14M	34	DL-06	22	FF-204	46	FM-67	6	GF-22	14	MF-205	31	P-267	11	VF-127	20
BD-57	30	BV-15	34	DL-58	33	FF-205	46	FM-68	6	GF-29	14	MF-206	31	PEB-1	24	VH-20	32
BD-58	30	BV-16	34	DL-78	22	FF-206	46	FM-69	6	GF-75	14	MIR-12	20	PEB-2	24	VH-21	32
BD-59	30	BV-108	34	DL-79	22	FG-1TC	6	FM-100	7	GF-76	14	MO-8	26	PEB-3	24	VH-48	21
BD-73	9	BV-109	34	DL-102	23	FG-2TC	6	FM-102	7	GF-77	14	MO-10	26	PEB-5	24	VH-49	21
BD-80	10	BV-315	47	DL-103	23	FG-10	3	FM-104	7	KO-47	46	NK-21	29	PF-19	15	VH-50	21
BD-92	9	BV-316	47	DL-112	23	FG-31	5	FM-180	3	L-21	21	NK-22	29	PF-22	15	VH-51	21
BD-130	30	CT-555N	49	DO-63	36	FG-32	5	FM-296	8	L-26	21	NK-23	29	PH-58	39	WG-12	36
BD-131	30	CT-556N	49	DO-267	36	FG-209	26	FM-297	8	L-27	21	NK-24	29	PH-65	17	WG-14	36
BD-132	30	CT-560N	49	DP-41	32	FG-210	26	FM-300	8	L-28	21	NK-25	29	PH-72	16		
BD-135	31	CT-564N	49	DR-84	32	FK-48	37	FM-301	8	L-29	21	NK-26	29	PH-75	16		
BD-136	31	CT-565N	49	DR-50	21	FK-49	37	FM-306	7	LB-361	29	NK-45	48	PH-85	17		
BD-141	9	CT-569N	49	DR-60	21	FK-51	37	FM-308	8	LB-364	29	NK-46	29, 48	PH-102	17		

EN / Graphic images in our Catalogue are for references only and not binding. We reserve the right to modify esthetically and technically without prior notice. To reprint this catalogue - or any part of it - without our final approval, is prohibited.

DE / Die Abbildungen in unseren Katalogen sind nicht bindend für unseren Betrieb. Wir behalten uns das Recht auf Änderungen in Aussehen und Abmessungen vor, ohne vorherige Ankündigung. Der Nachdruck des Kataloges - auch auszugsweise - ist ohne unser ausdrückliches Einverständnis untersagt. Geschmacksmuster angemeldet.

FR / Les images graphiques dans les catalogues sont à titre de références. Nous réservons le droit de modifier de façon technique et/ou esthétique sans préavis. La production totale ou partielle de ce catalogue - sans notre accord - est interdite.

ES / Las imágenes en nuestro catálogo son sólo referenciales. Nos reservamos el derecho modificarlas técnica o estéticamente sin previo aviso. Prohibida la reproducción total o parcial del catálogo sin el consentimiento explícito de la empresa.

IT / L'immagine raffigurata sui nostri cataloghi non è vincolante per l'azienda, che si riserva il diritto di apportare modifiche estetiche o tecniche senza alcun preavviso. È vietata la riproduzione totale o parziale del presente catalogo senza il nostro consenso.



BMT Germany | Headquarters
Moltkestraße 37-39, D-78532
Tuttlingen, Deutschland
Office: + 49 7461 96 67 50
Fax: + 49 7461 96 67 52

BMT North America
Tel: + 1 888 333 3044

BMT Latin America
Tel: + 1 514 384 3293

BMTsurgical.com
info@bmtsurgical.com

DISTRIBUÉ PAR | DISTRIBUTED BY



190, Boul. St-Elzéar Ouest, Laval (Québec) H7L 3N3
T 450 669.8985 | 1 800 361.0877
F 450 669.9532 | 1 888 935.7001

www.mtm.ca

