

Intelect[®]?

SHORTWAVE 100



User Manual

Operation & Installation
Instructions for:

Intelect Shortwave 100
REF 1602

Intelect Shortwave 100 (Canada)
REF 1604



TABLE OF CONTENTS

- **FOREWORD** 1
 - ▶ **Product Description** 1
 - ▶ **General Information** 2
- **SAFETY INSTRUCTIONS** 4
 - ▶ **Precautionary Definitions** 4
 - ▶ **Cautions** 5
 - ▶ **Warnings** 6
 - ▶ **Dangers** 10
 - ▶ **Personal Safety** 12
 - ▶ **Protection of the Unit** 14
- **ABOUT SHORTWAVE DIATHERMY** 16
 - ▶ **Overview** 16
 - Pulsed Shortwave Diathermy - Introduction 16
- **INDICATIONS** 17
 - ▶ **General** 17
- **CONTRAINDICATIONS** 20
 - ▶ **General** 20
- **ADDITIONAL PRECAUTIONS** 24
 - ▶ **General** 24
- **SETUP** 26
 - ▶ **Unpacking the Unit** 26
 - Inspection 26

- ▶ **Requirements for Installation** 27
 - Requirements for the Installation Location 27
- **NOMENCLATURE** 28
 - ▶ **Front View** 28
 - ▶ **Rear View** 29
 - ▶ **User Interface** 30
 - ▶ **Software Symbols** 31
 - ▶ **Accessories** 32
 - Capacitive Electrodes 32
 - Flexible Rubber Electrodes 32
 - Monode (Drum) Electrode 33
 - Diplode Electrode 33
 - Indicator Discharge Tube 33
- **SPECIFICATIONS** 34
 - ▶ **Unit Specifications** 34
 - Operating Data and Ratings 34
 - Software 35
 - Transport and Storage Conditions 35
 - Safety 35
 - ▶ **Applicator Specifications** 36
 - Load Resistance and Applicator Spacing 36
 - ▶ **Description of Device Markings** 37
- **OPERATION** 38
 - ▶ **Description of Functions** 38





TABLE OF CONTENTS

Introduction.....	38	▶ Using Clinical Protocols	56
Applications.....	38	▶ Retrieving, Deleting, and Saving User Protocols.....	58
Shortwave Diathermy in the Capacitive (Dielectric) Field	39	Retrieving User Protocols	58
Shortwave Diathermy in the Inductive Field	40	Deleting User Protocols	58
▶ Installing the Applicators.....	41	Saving New User Protocols.....	59
Installing the Capacitive Electrodes	41	Editing Existing User Protocols	60
Installing the Monode (Drum) Electrode.....	43	▶ Using Clinical Resources - Educational Library	61
Installing the Flexible Rubber Electrodes	45	Anatomical Graphics Library	61
▶ Preparing the Unit for Therapy.....	46	Electrode Placement Library	62
▶ Preparing the Patient for Therapy.....	47	Diathermy Rationale.....	64
▶ Basic Operation.....	48	Contraindications.....	64
▶ Starting Therapy.....	49	▶ Using Clinical Resources - Patient Card	65
Home Screen	49	Patient Card	65
Edit Treatment Screen	49	Edit Pain Profile.....	66
Electrode Screen	50	Saving Treatments to the Patient Card.....	68
Thermal Dosimetry	51	Erasing Patient Card	69
Quick Link Indications	52	▶ Using Clinical Resources - Unit Settings.....	70
Starting Therapy from the Home Screen.....	52	Adding and Changing the Clinic Name	70
Using the Indicator Discharge Tube	53	Increasing and Decreasing the Unit Volume	70
▶ Stopping, Pausing, and Completing Therapy.....	54	Setting the Date and Time	71
Stopping Therapy Using the STOP Button	54	Resetting Unit Settings	71
Stopping Therapy Using the Patient Interrupt Cord.....	54	Resetting Default Protocols	71
Pausing Therapy	55	Changing Languages	72
Completing the Therapy Session	55	▶ Using the Applicators	74
		Using the Capacitive Electrodes.....	74
		Using the Monode (Drum) Electrode	75





TABLE OF CONTENTS

Using the Flexible Rubber Electrode.....	76	▶ Optional Accessories	88
▶ Treatment Tips	78	● WARRANTY	89
Positioning the Electrodes	78	● APPENDIX A - EMC TABLES	90
Positioning of Electrodes - Edge Effect.....	78	▶ Table 1: Guidance and Manufacturer’s Declaration– Electromagnetic Emissions	90
Positioning of Electrodes - Edge Effect and Metal Objects	78	▶ Table 2: Guidance and Manufacturer’s Declaration– Electromagnetic Immunity	91
Positioning of Electrodes - Electrode Constriction	79	▶ Table 3: Recommended Separation Distances between Portable and Mobile RF Communications Equipment and the Intelect Shortwave 100	93
Positioning of Electrodes - Normal Cases	80		
Setting the Electrode - Skin Distance	81		
Dosage Levels According to Schliephake	82		
● TROUBLESHOOTING	83		
▶ Errors	83		
Error Codes and Descriptions	83		
Using the Indicator Discharge Tube	84		
● MAINTENANCE	85		
▶ Maintaining the Intelect Shortwave 100	85		
Routine Maintenance.....	85		
Cleaning and Disinfection.....	85		
Safety Inspections	85		
Service	87		
Warranty Repair/Out of Service Repair.....	87		
● ACCESSORIES	88		
▶ Standard Accessories	88		





This manual has been written for the owners and operators of the Intelect® Shortwave 100 system. It contains general information on the operation, precautionary practices, and maintenance information. In order to maximize use, efficiency, and the life of your unit, please read this manual thoroughly and become familiar with the controls, as well as the accessories, before operating the unit. This manual contains general safety, operating, maintenance, and care instructions for the owners and operators of the Intelect Shortwave 100 system.

Specifications put forth in this manual were in effect at the time of publication. However, owing to Chattanooga Group's policy of continual improvement, changes to these specifications may be made at any time without obligation on the part of Chattanooga Group.

Before administering any treatment to a patient, the user of this equipment should read, understand, and follow the information contained in this manual for each mode of treatment available, as well as the indications, contraindications, warnings, and precautions. Consult other resources for additional information regarding the application of shortwave diathermy.

Product Description

The Intelect Shortwave 100 utilizes both inductive and capacitive electrodes to administer the clinical application of oscillating electromagnetic energy in the radio frequency of 27.12 megahertz to treat a wide variety of orthopedic and physiotherapeutic conditions. Diathermy generates deep heat within body tissues to increase circulation, decrease pain, decrease inflammation, increase ROM, influence muscle tone, and facilitate the sub acute healing phase.

Stay current with the latest clinical developments in the field of shortwave diathermy. Observe all applicable precautionary measures for treatment.

Keep informed on appropriate indications and contraindications for the use of shortwave diathermy.

This equipment is to be used by, and sold to, a trained clinician only under the prescription and supervision of a licensed practitioner.

©2009 Encore Medical, L.P. and its affiliates, Austin, Texas, USA. Any use of editorial, pictorial, or layout composition of this publication without express written consent from Chattanooga Group of Encore Medical, L.P. is strictly prohibited. This publication was written, illustrated, and prepared for print by Chattanooga Group of Encore Medical, L.P. Certain portions of this manual have been reproduced with the consent of gbo Medizintechnik AG.





FOREWORD

GENERAL INFORMATION

The Intelect Shortwave 100 unit and the accompanying components and individual elements fulfill, as a unit, the currently valid safety standards and comply with the stipulations of IEC 60601-1 and the medical products regulations.

The unit and its external components (accessory elements) are safe if used properly and in compliance with the explanations and instructions provided in this documentation. Nevertheless, the unit or its external components can pose dangers. Therefore, we urgently recommend that anyone operating the shortwave diathermy unit become aware of the potential dangers of the unit and its external components before beginning work.

Please read and observe all safety instructions in this operating manual.

The following features are available on the Intelect Shortwave 100 unit:

Clear Touch Screen LCD

Allows the operator to select an option on the screen by simply touching it. Guides the operator through the setup process providing continuous feedback about treatment settings. Gives the operator optimal visibility during attended procedures. Allows the operator to turn on the unit simply by pressing the LCD.

Clinical Protocols™

An efficient approach for setting up a treatment using preset parameters.

Thermal Dosimetry

Allows the operator to set up a treatment using the four treatment dosages according to Schliephake (see [page 82](#)).*

*Low and Reed (1990)





FOREWORD

GENERAL INFORMATION (CONTINUED)

Quick Link Indications

The Intelect Shortwave 100 incorporates a unique Quick Link Indications section which allows the user to select specific clinical indications and apply the most common therapy for the Indication selected. All modalities are editable, in their normal editing fashion, in order to customize the treatment for each patient's prescribed therapy.

User Protocols

User protocols allow you to set, save, and change the parameters of each program (protocol) in order to tailor it to meet your patients' specific needs. You may create up to 200 user protocols.

Automatic Tuning

The Intelect Shortwave 100 has been programmed to automatically regulate the power between the electrodes and the patient.

Screen Saver

The screen saver function acts like any other screen saver on a normal computer to reduce LCD screen burn-in. The unit will enter screen saver mode after 10 minutes of inactivity. If the user presses the touch screen or any button on the User Interface, it will return to the Home screen.

Realtime Clock

The Realtime Clock keeps track of date and time even when the unit is turned off or unplugged.





SAFETY INSTRUCTIONS

PRECAUTIONARY DEFINITIONS

The precautionary instructions found in this section and throughout this manual are indicated by specific symbols. Understand these symbols and their definitions before operating this equipment. The definition of these symbols are as follows:



Text with a "CAUTION" indicator will explain possible safety infractions that could have the potential to cause minor to moderate injury or damage to equipment.



Text with a "WARNING" indicator will explain possible safety infractions that will potentially cause serious injury and equipment damage.



Text with a "DANGER" indicator will explain possible safety infractions that are imminently hazardous situations that would result in death or serious injury.



Explosion Hazard

Text with an "Explosion Hazard" indicator will explain possible safety infractions if this equipment is used in the presence of flammable anesthetics.



Dangerous Voltage

Text with a "Dangerous Voltage" indicator serves to inform the user of possible hazards resulting in the electrical charge delivered to the patient or operator in certain treatment configurations.



Non-ionizing Electromagnetic Radiation

Text with a "Non-ionizing Electromagnetic Radiation" indicator informs the user of possible hazards resulting from elevated, potentially dangerous, levels of non-ionizing radiation.



Refer to Instruction Manual/Booklet

NOTE: Throughout this manual, "NOTE" may be found. These Notes are helpful information to aid in the particular area or function being described.



CAUTION

- Read, understand, and practice the precautionary operating instructions. Know the limitations and hazards associated with using any shortwave diathermy device. Observe the precautionary and operational decals placed on the unit.
- DO NOT operate the Intelect Shortwave 100 in conjunction with any other devices.
- DO NOT operate this unit in an environment where other devices are being used that intentionally radiate electromagnetic energy in an unshielded manner. Portable and mobile RF communications equipment can affect medical electrical equipment.
- The unit should be routinely checked before each use to determine that all controls function normally, especially that the output control does properly adjust the intensity of the shortwave diathermy power output in a stable manner. Also, determine that the treatment time control does actually terminate shortwave diathermy power output when the timer reaches zero.
- DO NOT use sharp objects such as a pencil point or ballpoint pen to operate the buttons on the control panel as damage may result.
- This unit should be transported and stored in temperatures between -40 °C and 70 °C (-40 °F and 158 °F) to prevent damage to the unit or its components.
- Handle shortwave diathermy accessories with care. Inappropriate handling of the accessories may adversely affect their characteristics.

CAUTION

- Inspect cables, electrodes, associated connectors, and accessories before each use. To test the Patient Interrupt Cord, follow the procedures listed in "Stopping Therapy Using the Patient Interrupt Cord" on [page 54](#).
- External conductive material should be removed from the immediate treatment area.
- Do not use accessories other than those supplied with the unit, or recommended by Chattanooga Group. The safety of other products has not been established, and their use could result in injury to the patient and degrade minimum safety.
- Disconnect the power supply cord before removing covers on this equipment. Refer the servicing of this unit to qualified service personnel.
- This equipment has an output that is capable of producing a physiological effect.
- Grounding reliability can only be achieved when the equipment is connected to an equivalent receptacle marked "Hospital Only" or "Hospital Grade."
- Medical electrical equipment needs special precautions regarding EMC and needs to be installed and put into service according to the EMC information provided in this manual.





CAUTION

- This unit generates, uses, and can radiate radio frequency energy and, if not installed and used in accordance with the instructions, may cause harmful interference to other devices in the vicinity. However, there is no guarantee that interference will not occur in a particular installation. Harmful interference to other devices can be determined by turning this equipment on and off. Try to correct the interference using one or more of the following: reorient or relocate the receiving device, increase the separation between the equipment, connect the equipment to an outlet on a different circuit from that to which the other device(s) are connected, and consult the factory field service technician for help.
- Medical devices that are to be used within 12 meters of the Intelect Shortwave 100 should have an electromagnetic site survey completed. See NOTE 2 on [page 92](#) for more information.
- To determine the distance of separation for all equipment operating near the Intelect Shortwave 100, consult the EMC tables applicable to the other equipment. If the distance cannot be determined, make certain that the other equipment is operated from a distance of no less than 12 meters.
- This equipment is to be used by, and sold to, a trained clinician only under the prescription and supervision of a licensed practitioner.



WARNING

- Since relatively high powers are used, there is the possibility of producing shock, localized burns, and cataracts if the patient is unaware of the heat due to reduced thermal sensation, or if the patient does not know what to expect during treatment.
- Improper installation, operation or maintenance of the shortwave diathermy system may result in malfunctions of this unit or other devices.
- In case of display failure or other obvious defects, switch the unit off immediately by means of the power switch, disconnect the power cord from the power outlet, and notify a certified service technician.
- Be aware that some synthetics and plastics, though assumed to be non-conductive, may be heated by shortwave diathermy.
- Adjustments or replacement of components may result in the equipment failing to meet the requirements for interference suppression.
- If the unit cannot be installed immediately after delivery, the unit and its external components or accessory elements must be stored in their original packaging in a dry place.
- Do not store or operate the unit in a dusty environment.
- Do not cross cables.
- Keep all electrodes, accessories, and their cords separated during treatment by using the cable clips located on the side of the arm extenders. Electrodes or their cords in contact with each other during treatment could result in improper stimulation, skin burns, or damage to the cord or electrode.





WARNING

- Do not lean on or hold the cables during treatment.
- Keep all line cords away from the diathermy unit cables. Do not store or coil line cords where they can come close to the cables on an operating shortwave diathermy unit.
- This equipment is not designed to prevent the ingress of water or liquids. Ingress of water or liquids could cause malfunction of internal components of the system and therefore create a risk of injury to the patient.
- Care must be taken when operating this unit adjacent to or stacked with other equipment. If adjacent or stacked use is necessary, the Intelect Shortwave 100 should be observed to verify normal operation in the configuration in which it will be used. Potential electromagnetic or other interference could occur to this or other equipment. Try to minimize this interference by not using other equipment in conjunction with it.
- Use only accessories that are specially designed for this unit. Do not use accessories manufactured by other companies on this unit. Chattanooga Group is not responsible for any consequence resulting from using products manufactured by other companies. The use of other accessories or cables (other than those specified) may result in increased emissions or decreased immunity of this unit.



WARNING

- Metal in treatment area will provide low impedance paths to the induced radio frequency current, producing local heating and the possibility of burning. In particular, treatment should never be given in the area of metal implants. Also, metal jewelry, buckles, cell phones, etc must be removed.
- Use of controls or adjustments or performance of procedures other than those specified herein may result in hazardous exposure to shortwave diathermy energy.
- Make certain that the unit is electrically earthed by connecting only to a earthed electrical service receptacle, conforming to the applicable national and local electrical codes.
- This device should be kept out of the reach of children.
- Induction field electrodes that are operated without a patient could be destroyed due to overheating.
- Make certain that the electrode arms and arm extenders are locked firmly into place during shortwave diathermy therapy using the front and rear handwheels to prevent unintentional movement. See [page 28](#) for the nomenclature of the unit.
- Do not leave patient unattended during shortwave diathermy therapy.





SAFETY INSTRUCTIONS



WARNING

- Remove the electrode applicator by pulling the cable connector only. DO NOT remove by pulling the cable.
- To remove the cable from the applicator, make certain the power is off. While the electrode applicator is being supported by the electrode arm, hold the electrode while removing the cable to prevent the electrode from dropping to the floor.
- Tighten arms so that they do not move during therapy.
- Observe the patient and the position of the arms at all times during therapy.
- Inform the patient that the arms are not supposed to move during therapy.
- Before using the unit, verify the patient is not in contact with the unit, the electrode connection cable, the electrodes, or other devices or metal objects.



WARNING

- In the event that an Error message or Warning appears beginning with a 2 or 3, immediately stop all use of the unit and contact the dealer or Chattanooga Group for service. Errors and Warnings in these categories indicate an internal problem with the unit that must be tested by Chattanooga Group or a Field Service Technician certified by Chattanooga Group before any further operation or use of the system. Use of a unit that indicates an Error or Warning in these categories may pose a risk of injury to the patient, user, or extensive internal damage to the system.





DANGER



- Do not administer shortwave diathermy to a patient who has had an implant in the past unless you are absolutely certain that the implant and all leads in their entirety have been removed. Note that the leads are often left implanted after the implant is removed.
- This unit generates non-ionizing radiation. Patients with implanted electronic devices, such as cardiac pacemakers and defibrillators, cochlear implants, bone growth stimulators, deep brain stimulators, spinal cord stimulators, and other nerve stimulators, must not be treated, even if the device has been turned off.
- The function of certain implanted devices (e.g., pacemakers) may be adversely affected during treatment with shortwave diathermy. In case of doubt, the advice of a licensed practitioner in charge of the patient should be sought.
- Shortwave diathermy should not be used on patients who have any implanted metallic lead or any implanted system that may contain a lead. Both the heating and non-heating modes of operation pose a risk of tissue destruction. If you are a licensed practitioner who implants or monitors patients with leads or implanted systems with leads, explain to the patient what diathermy is and stress that they should not receive shortwave diathermy treatment. If you are a licensed practitioner who uses diathermy in your practice, be sure to ask patients about possible implants before deciding to administer shortwave diathermy.



DANGER

- Other equipment, including patient connected devices, may be adversely affected when in close proximity to shortwave diathermy equipment.
- Patients should not be treated with shortwave diathermy when they have reduced thermal sensitivity over the proposed area of treatment, unless the physician in charge of the patient is notified.
- Treatment should not be given through clothing, although it is permissible to administer treatment through a dressing or plaster in pulsed modes.
- Remove hearing aids prior to treatment.
- At average power levels above 5 W, patients should not be allowed to come into contact with conductive parts which are earthed or which have an appreciable capacitance to earth and which may provide unwanted pathways for the radio frequency current. In particular, treatment must never be given with the patient on metal framed couches, chairs, or beds. Do not use conductive mattresses or mattress covers.
- Before increasing the output in response to a report of inadequate patient heating, verify that the cables are properly routed, spaced correctly, and away from metal or grounded objects. The heating effect may be misdirected and heating may be occurring in an unwanted area.
- Before each use, check the condition of the housing and the insulation of the electrodes, electrode connection cable, and the power supply cable. Also make sure that the cables have been routed correctly.





DANGER



- If the unit is not safe for operation, then it must be repaired by certified service personnel and the operators must be informed of the dangers posed by the unit.
- In order to prevent electrical shock, unplug the power plug from the socket before cleaning or disinfecting the unit.
- Under no circumstances may liquid penetrate the openings on the unit, e.g. the connecting sockets of the electrode cables. Therefore, do not use cleaning or disinfectant sprays.
- The unit, electrodes, and cables may not be sterilized using steam or gas.
- Never clean the unit with abrasives, disinfectants or solvents that could scratch the housing or damage the unit.
- Internal burns can occur with the incorrect application of shortwave diathermy due to excessive intensity.
- Internal burns can occur with the incorrect application of shortwave diathermy due to excessive exposure time.
- Do not perform unauthorized repairs under any circumstances.
- The unit and the electrodes must be positioned so that there is no danger of personal injury. Therefore, you must read and observe the safety instructions and the list of contraindications before putting the unit into operation.

DANGER



- The Electrode-Skin Distance (ESD) must be small for surface warming and large for depth warming. A larger Electrode-Skin Distance (ESD) is necessary for patients with a thick layer of subcutaneous fat in order to achieve the necessary warming of deep-lying tissue.
- Explosion hazard if Intellect Shortwave 100 is used in the presence of flammable anesthetics mixture with air, oxygen, or nitrous oxide.
- The operator should not use diathermy over the heart in order to prevent theoretical cardiac signal interference.
- Never, under any circumstances, attempt to hold any of the electrodes in your hands during therapy.
- The unit must be installed so that there is no danger to the patient, the operator or other persons. Therefore, you must read the safety instruction and contraindications.
- Keep all unnecessary persons out of the treatment location. No other person should be located within 3 meters of the unit.
- The Intellect Shortwave 100 unit may contain Di (2-ethylhexyl) phthalate (DEHP) which is the plasticizer for most PVC medical devices. Everyone is exposed to small levels of DEHP in everyday life. However, some



DANGER

Individuals can be exposed to high levels of DEHP through certain medical procedures. DEHP can leach out of plastic medical devices into solutions that come into contact with the plastic. The amount of DEHP that will leach out depends on the temperature, the lipid content of the liquid, and the duration of contact with the plastic. As a preventative measure, use PVC devices that do not contain DEHP, or devices made of other materials such as ethylene (EVA), silicone, polyethylene, or polyurethane for all clinical procedures. Avoid using DEHP-leaching PVC when performing all clinical procedures on male neonates, pregnant women who are carrying male fetuses, or peripubertal males.

- The Intellect Shortwave 100 unit may contain bisphenol-A (BPA) which is a building block of polycarbonate plastic used to make numerous consumer products (baby bottles, 5 gallon water bottles, etc). This chemical is considered an Unclassifiable Carcinogen and a suspected Endocrine disruptor which may interfere with or block hormones. BPA is highly toxic if swallowed, absorbed through the skin, or inhaled.

DANGER

- In case of damage from transport that could endanger personal safety, the unit must not be connected to the Mains Power Supply before inspection is complete.
- Adhere to rules, regulations, and ordinances that may vary from location to location concerning the appropriate use of high powered radio frequency fields.
- Since the effects of high-frequency fields on unborn life have not yet been sufficiently researched, we recommend that operators who are pregnant are not within 15 meters of the applicator when the unit is activated.
- Any persons with pacemakers or implants must remain outside of the treatment area during shortwave diathermy. No one wearing a cardiac pacemaker should be within 15 meters of an operating unit.



SAFETY INSTRUCTIONS

PERSONAL SAFETY

In case of improper or unauthorized use of the unit, the operator, the patient or other persons may be subjected to the danger of electric shock due to high voltage produced by the unit, the danger of influence on active implantations by magnetic fields produced by the unit and the danger of being burned due to erroneously positioned electrodes or false parameters such as the duration of treatment, power output or operating mode.

Before operating the unit, please read this instruction manual carefully and observe the information contained therein.

Pay special attention to the list of contraindications. Refer to "Safety Instructions" on [pages 5-11](#), "Contraindications" on [pages 20-23](#), and "Additional Precautions" on [pages 24-25](#).

Before operating the unit each time, verify that:

- the unit has been correctly connected to the Mains Power Supply.
- the unit has been set up so that it is free-standing and the patient is not in direct contact with metal objects such as heating radiators, metal beds, or other equipment.
- the insulation of the RF output jack and electrode connection cables is not damaged.
- the electrode connection cable is connected properly and is not cross-routed (which may cause capacitive short circuits).
- only accessories (cables, electrodes) approved by the manufacturer are connected.

- the patient to be treated (and the personnel) have removed all electric devices (e. g. hearing aids, electrotherapy electrodes, mobile telephones) and all conductive objects (e.g. rings, chains, watches, earrings or other jewelry, eyeglasses) and that they are not in the immediate vicinity of the unit, the patient is in a composed state and the bodily areas to be treated are dry on the exterior.
- the electrodes are positioned according to the doctor's instructions (to be checked by the doctor or physiotherapist if applied by assisting personnel).
- there are no unneeded personnel in the room other than the operator and the patient.
- there is no danger of unwanted local warming due to electrode constrictions.

Before using the unit, speak with the patient to verify:

- the patient is in a comfortable position during the entire treatment.
- the patient is not in contact with the unit, the electrode connection cable, the electrodes, or other devices or metal objects.
- that the patient is comfortable before and during treatment.





SAFETY INSTRUCTIONS

PERSONAL SAFETY (CONTINUED)

Before using the unit, determine the maximum nominal output power of the respective accessory in order to avoid overheating the tissue.

At regular intervals during the treatment, verify:

- that the unit is functioning properly
- that there is no moisture development* (perspiration) in the area of the electrodes
- if the patient feels well.**

After the treatment, ask the patient about the tolerance of the treatment. The treatment environment should be inspected by a licensed practitioner.

* The affected parts of the body should be unclothed during treatment, since accumulation of moisture on the skin or in folds can cause local overheating of the skin. This is especially important in the event that the patient is wearing clothing made of moisture-resistant fabric such as silk or synthetic fibers.

** The output power must always be set according to the subjective response of the patient. Particular care is to be taken with patients who have a reduced capacity for heat perception (see the dosage levels according to Schliephake on [page 82](#)).





SAFETY INSTRUCTIONS

PROTECTION OF THE UNIT



WARNING

Improper installation, operation or maintenance of the shortwave diathermy unit may result in malfunctions of this unit or other devices.

Observe the following instructions in order to prevent malfunctions:

- In order to prevent electromagnetic disturbances, place the unit at least 12 meters (see the Caution on [page 6](#) for more information) from any other devices. Also make sure that there is sufficient distance between the unit and Mains Power Supply or data cables in walls, ceilings and floors, since the electromagnetic radiation from the unit can pass these essentially without hindrance.
- In selecting the location for the unit, make sure that the patient has contact during the treatment to the non-earthed application element and, due to equalizing currents in case of differing potentials, that the patient is never in contact with metal elements (especially if they are earthed), such as heating radiators, metal beds or other earthed devices.

Before connecting the unit, make sure that:

- the voltage rating on the safety label corresponds to the available system voltage.
- the frequency rating on the rating plate corresponds to the system frequency.
- an earthed socket outlet with earthing contact is available for connecting the unit.
- the routing of the power cable from the unit to the socket outlet with earthing contact does not pose a danger for personnel or the patient.
- the Mains Power Supply is designed for the comparatively high (possibly additional) power input of the unit (~ 1500 VA) and the line is sufficiently protected in accordance with regulations.



WARNING

Make certain that the unit is electrically earthed by connecting only to a earthed electrical service receptacle, conforming to the applicable national and local electrical codes.





SAFETY INSTRUCTIONS

PROTECTION OF THE UNIT (CONTINUED)

Do not connect the unit to the Mains Power Supply until the following requirements have been met:

- Before putting the unit into operation, check to make sure that the electrode connection cable and the electrodes are undamaged and have been connected correctly to the unit.
 - Never operate the unit with open outputs, (i.e. without electrodes).
 - Do not operate the unit for an extended period with no load (without a patient), especially in coil (induction field) mode. When operating the unit without power output, induction field electrodes could be destroyed due to overheating.
 - Pay attention to the routing of the electrode connection cables. These must always be in the air and must never lie on surfaces.
 - Other than Chattanooga Group equipment, keep chip cards, magnetic cards, audio and video cassettes, and other data media susceptible to interference away from the unit.
 - Clean and disinfect the unit only when the Mains Power Supply is deactivated (power switch off, power plug disconnected).
 - Clean and disinfect the unit only by means of disinfection by wiping. Disinfecting by spraying can damage the unit due to penetrating moisture.
- Never clean the unit with abrasives, disinfectants, or solvents that could scratch the housing or damage the unit.
 - Never perform unauthorized service work. All service work must be performed only by service technicians who have been authorized by the manufacturer.





ABOUT SHORTWAVE DIATHERMY

OVERVIEW

Shortwave refers to electromagnetic radiation in the frequency range 2 to 100 MHz. Shortwave diathermy is the application of electromagnetic energy to the body at shortwave frequencies. At these frequencies, the electromagnetic energy is converted to thermal energy by the induction of circulating currents in the tissue and dielectric absorption in insulating tissue. Shortwave diathermy units may produce varying output power levels providing significant heat to the area of the body being treated. To avoid equipment such as shortwave diathermy units interfering with radio communications, certain frequency ranges are designated by international agreement as ISM (Industrial, Scientific, and Medical) bands.

Shortwave diathermy equipment normally uses the band centered on 27.12 MHz. This corresponds to a wavelength, in a vacuum, of approximately 11 meters.

Shortwave diathermy is normally applied at a level which produces detectable heating and the benefits are those associated with the heating effect (encouragement of healing, pain relief, reduction of muscle spasm, increase in mobility, etc.).

The difference between shortwave diathermy and other methods of heating is that it provides “deep heat.” Other heating techniques such as infrared therapy, hot packs, etc., provide the heat externally whereas shortwave diathermy generates heat within the tissue.

Pulsed Shortwave Diathermy - Introduction

Pulsed shortwave diathermy equipment delivers the energy in pulses or bursts of shortwave energy. The pulses are typically 20 to 400 μ sec in duration (pulse width) and are repeated with a frequency of 10 to 800 Hz (pulse frequency). As with other modalities such as ultrasound, it is found that delivering the energy in pulses is often therapeutically more beneficial than providing the same amount of energy in continuous waveform. Pulsed shortwave diathermy appears to be effective for many conditions especially in the early stages of recovery.

Because the output is pulsed, the average output power levels can be very low (less than 1 W) and still produce the effective treatment. The Intellect Shortwave 100 in pulsed mode provides a peak power of 200 W and average powers from a few mW to 64 W.

As the power levels are lower than with conventional shortwave diathermy equipment, some of the potential dangers associated with the modality no longer apply.





INDICATIONS

GENERAL

Shortwave therapy is the application of electromagnetic energy to the body at shortwave frequencies. Shortwave therapy equipment normally uses 27.12 MHz to produce the desired deep heating effect on the tissues of the body. At these frequencies, electromagnetic energy is converted to thermal energy by the induction of circulating currents in the insulating tissue.

The heating effect produced by Shortwave diathermy aids the healing process by generating heat deep within the tissue resulting in numerous beneficial effects.

Shortwave therapy is indicated for the following:

Osteoarthritis

Chronic and acute joint disorders (knee, hip, shoulder, elbow, hand, foot and mandibular joints)

Chronic Polyarthritis of the Hip and Shoulder Joints

Inflammation of more than one joint

Tendonitis/Tendinosis

Chronic and acute inflammation or injury to the tendons

Shin Splints

Painful condition of the shins

Bursitis

Bursal synovitis

Distortions, Dislocations, and Contusions

Twisted joints, overextended joints, sprains, dislocations (luxation), crushing, injury due to brute force (contusion)

Epicondylitis

Tennis elbow, inflammation of tendon attachments on cubital or radial part of elbow joint (humeral)

Sinusitis

Inflammation of the paranasal passages

Fractures

Broken bones

Intercostal Neuralgia

Nerve pain. Acute, painful irritation starting from the thoracic spine; Possible causes of this are nerve root compressions and acute blockages in the area of the kinetic elements or the joint faces of the vertebral bodies





INDICATIONS

GENERAL (CONTINUED)

Ischialgia

Pain in ending of nervus ischiadicus, always radicular, usually caused by damaged intervertebral disc

Contracture

Loss of motion in a joint due to the shortening of soft tissue

Lumbago

Muscle pain in the lumbar region, lumbar rheumatism

Myalgia

Muscle pain

Neuralgia/Neuritis

Nerve pain, nerve inflammation

Frozen Shoulder

Shoulder pain accompanied by limitation of movement

Periostitis

Cortical osteitis

Fibrositis/Fibromyalgia

Condition classified by the presence of chronic widespread pain

Spondylosis / Osteochondrosis

Arthrosis of the vertebral bodies or degeneration of the intervertebral discs

Carpal Tunnel Syndrome

Medical condition in which median nerve is compressed at the wrist causing pain and muscle weakness

Tendovaginitis

Inflammation of tendon and sheath; Painful grating or chafing of the affected tendon after overstraining or dull trauma

Cervical syndrome

Post-traumatic neck syndrome; Refers to afflictions beginning in the cervical spine that can emanate into the shoulder muscles or arms

Piriformis Syndrome

Neuromuscular disorder when sciatic nerve is compressed or otherwise irritated by the piriformis muscle



INDICATIONS

GENERAL (CONTINUED)

Morton's Neuroma

Benign neuroma of the interdigital plantar nerve

Plantar Fasciitis

Inflammatory condition of the foot caused by excessive wear to the plantar fascia that supports the arch

Rotator Cuff Tear/Repair

Tears of one or more of the four tendons of the rotator cuff muscles

Torticollis

Condition in which head is tilted to one side, chin elevated and turned to opposite side

Plica Syndrome

Occurs when plica in the knee becomes irritated or inflamed

Retropatellar Pain Syndrome

Inflammation of the patellar tendon in the knee





CONTRAINDICATIONS

GENERAL

The Intellect Shortwave 100 unit is contraindicated for the following:



- Any patient with an implanted electronic device such as a cardiac pacemaker, bladder stimulator, spinal cord stimulator or electrodes for a myoelectric prosthesis, or implanted metallic leads, must not be treated with shortwave diathermy and should not be subjected to shortwave diathermy. Do not use on patients who have had an implant in the past unless you are absolutely certain that the implant and all leads in their entirety have been removed. Note that leads are often left implanted after the implant is removed. The effects of the applied high frequency on the pacemaker could cause ventricular fibrillation. Any other persons with pacemakers must also remain outside of the treatment area during shortwave diathermy. No one wearing a cardiac pacemaker should be within 15 meters of an operating unit.
- Patients whose condition could be negatively affected by heat.
- Patients with hemorrhages or risk of hemorrhage.
- Patients with septic conditions and empyemas.
- Patients with malignant tumors and undiagnosed tumors.¹
- Implants, areas where implants have been removed, damaged implants, and metal inclusions.²
- Implants that could be impaired by shortwave diathermy irradiation.
- Swellings that still feel warm.
- Thermohypesthesia (diminished perception of temperature differences).
- Thermohyperesthesia (very acute thermoesthesia or temperature sense; exaggerated perception of hot and cold).
- Acute inflammations.
- Severe arterial obstructions (stage III and IV).
- Gynecological disorders involving acute inflammation³.
- Wetness, perspiration, or damp bandages.
- Permeating irradiation of the thorax in cases of severe heart diseases (heart valve diseases, myocardial insufficiency, myocardial infarct, severe coronary sclerosis).
- Pregnancy, since irradiation of the abdomen could cause teratogenous damage due to alterations of blood circulation and diffusion.
- During the menstrual cycle.
- Over the pregnant or potentially pregnant uterus. Therefore, shortwave diathermy should not be applied over the uterus unless specific assurance can be attained from the patient that she is not pregnant.
- Sudeck's syndrome, stage I and II.
- Basedow's disease (irradiation could cause serious states of agitation).
- Varicose veins (irradiation could cause congestive pain).
- Particular care must be taken if the patient's clothing is wet



CONTRAINDICATIONS

GENERAL (CONTINUED)

or damp, since the garments may heat up faster and more intensely than the patient's body.

- Synthetic fibers (perlon, nylon, etc.) are characterized by low absorbency, which can cause the skin beneath such fabrics to quickly become moist. Therefore, it is recommended that the body areas to be treated be completely unclothed and the patient's skin dried, particularly where perspiration accumulates in folds of the skin. This applies especially when a higher dosage is being applied. There is no danger, however, when applying shortwave diathermy irradiation to bandaged areas as long as the bandages are completely dry.
- When treating small children, particular care is obviously required due to the low body weight. Very careful dosing and constant observation (manual checks of the skin temperature while the unit is switched off) are necessary.
- Since the effects of high-frequency fields on unborn life have not yet been sufficiently researched, we recommend that operators who are pregnant are not within 15 meters of the applicator when the unit is activated.
- The output power must always be set according to the subjective response of the patient. Therefore, special care must be taken in case of patients with a diminished capacity for perception of heat (refer to "Dosage Levels According to Schliephake on [page 82](#)).
- It is advisable to post warnings for wearers of pacemakers in the rooms where high-frequency therapy (e.g. shortwave diathermy) is applied.
- A distance of at least 12 meters (see the Caution on [page 6](#) for more information) must be maintained between the unit and any low-frequency therapy that is being used.
- Cardiac conditions.
- Deep vein thrombosis, phlebitis, varices.
- Arterial disease, circulatory insufficiency.
- Over eyes.
- Over reproductive organs.
- Over cardiac pacemakers and defibrillators, cochlear implants, bone growth stimulators, deep brain stimulators, spinal cord stimulators, and other nerve stimulators.
- Over open lamina (after laminectomy; spina bifida).
- Over superficial endoprosthesis or metal implants.
- Directly over the carotid sinuses, ceruical stellate ganglion, or Vagus nerve located in the anterior neck triangle.
- Direct application over cancerous tumors or lesions due to its potential to increase blood flow to the area of malignancy.
- Neoplastic tissues or space occupying lesions.
- Occlusive vascular disease, such as arteriosclerosis obliterans and thromboangitis obliterans, in which organic occlusion and ischemia are evident.
- Directly over the epiphysis of growing bones in children

CONTRAINDICATIONS

GENERAL (CONTINUED)

and adolescents because shortwave diathermy therapy may enhance or inhibit bone growth.

NOTE: The mean age for skeletal maturity is 15 ½ years in females and 17 ½ years in males.

- In the presence of systemic or local infection (sepsis, Osteomyelitis, tuberculosis) or if the patient has an elevated temperature.
- In areas where metal is present due to eddy current generation of excessive and uneven heat distribution. Metal objects within the treatment area should be removed and placed outside the electromagnetic field. These include, but are not limited to metal:
 - **Metal in the environment:**
 - Within 0.3 m of beds, treatment tables, standard chairs, wheelchairs, swivel stools, step stools, splints, braces, scissors, forceps, and scalpels.
 - Within 12 meters (see the Caution on [page 6](#) for more information) of electronically controlled medical devices such as, CPM devices, electric wheelchairs, electrotherapy devices or other electrical systems, computers, etc.
 - **Metal near the patient:**
 - Jewelry, body piercing earrings, watches, keys, coins, belt buckles, underwire bra, hearing aids, zipper in

clothing or pillow cases.

- **Metal objects within the treatment area that cannot be removed should be avoided. These include, but are not limited to:**
 - External metal: orthodontic braces, dental fillings, staples, external fixation devices.
 - Internal metal: valves, joint replacements, metal IUDs, shrapnel, metal implants, internal fixation devices-rods, plates, screws, wires, etc.

NOTE: If there is a scar in or near the treatment area, check with the patient and/or the patient's chart to determine if there is metal under the scar.

¹According to Schneider (in *Elektromedizin* 7/62): Tissue and organ sections with inflammations, necroses, pus formation and abscesses. In such cases, the therapist must choose between the application of cold or heat in accordance with general pathological considerations, depending on the degree of inflammation. Inflammatory conditions that are still in statu nascendi are treated with cold. Inflammatory conditions with necroses and a cavitory tendency are treated with therapeutic means that generate heat and hyperemia. Chronic and unspecific inflammations are treated in the same way (heat and hyperemia), as this supports resorption, reparation and regeneration. Specific chronic inflammations (such as tuberculosis), however, are activated by heat. Accordingly, they represent a contraindication. The same applies in the case of malignant tumorous conditions. Heat application in the case of a tumorous disease can only be regarded as malpractice. Moreover, cardiac congestions must be removed prior to any heat application.



CONTRAINDICATIONS

GENERAL (CONTINUED)

²The higher conductivity of metals causes concentration of the field, producing a high temperature in the border area of the tissue. This, in turn, can cause excessive local heat, leading to (irreparable) third-degree burns. Therefore, caution is also necessary in case of long-existing metal inclusions, such as shell fragments.

³Further contraindications relating to gynecological disorders include (see Möbius, Gynecological University Clinic, Jena): genital tuberculosis, endometriosis, pyosalpinx or pyo-ovarium, tubal carcinoma.



ADDITIONAL PRECAUTIONS

GENERAL

When administering shortwave diathermy, keep in mind the following:

- Caution is advised in patients who cannot perceive or report pain or heat sensation accurately. Absent or diminished sensation should be avoided or, if unavoidable, treated with caution. Establishment of acceptable intensity levels for desensitized areas may be related to the intensity levels tolerated on normal skin in opposite or related body parts. Frequent monitoring of intensity level and skin response should occur during all treatments.
- Caution is suggested when using shortwave diathermy immediately after the application of superficial and deep heat or cold modalities. The application of thermal modalities prior to shortwave diathermy can alter the patient's perception of warmth and pain.
- Caution is advised when applying thermal shortwave diathermy directly to an area with impaired arterial blood supply because the compromised blood flow may not meet the increased metabolic demand placed on the tissues by the thermal energy dose. Always start with a low dose and observe patient response. Increase in dose may be made in subsequent treatments if the patient can tolerate the dosage given.
- Caution should be exercised when treating over adipose tissue. Excessive superficial heating can occur due to the high electrical resistance of subcutaneous fat to shortwave diathermy.
- Shortwave diathermy should be applied with caution over bone where minimal (bony prominence) or no (Stage IV wounds) soft tissue is present.
- Hearing aids should be removed.
- The function of other patient connected equipment may be adversely affected by the operation of the pulsed shortwave diathermy equipment. Maintain maximum distance between units in order to reduce any tendency to interaction.
- Any bleeding tendency is increased by heating because of the increase in blood flow and vascularity of the heated tissues. Care, therefore, should be used in treating patients with therapeutic shortwave diathermy who have bleeding disorders.
- Heating of the joint capsule in acute or subacute arthritis should be avoided.
- Use a single layer of toweling to absorb moisture during treatment with the inductive drum applicators.
- Shortwave diathermy may interfere with other electronic therapeutic devices such as neuromuscular stimulators and therapeutic ultrasound units. Never use another electronic device on the same patient when shortwave diathermy is being applied.



ADDITIONAL PRECAUTIONS

GENERAL (CONTINUED)

- Use caution when treating obese patients with capacitive electrodes since this method of application may heat fat excessively.
- Frequent monitoring of intensity level and skin response should occur during all treatments.





SETUP

UNPACKING THE UNIT

The unit is generally delivered with the packaging material supplied by the manufacturer. Since the unit weighs approximately 60 lbs (27.22 kg), it must be unpacked by at least 2 persons.

Proceed as follows:

- Position the transport packaging so that the arrows are pointing upward.
- Remove the safety bands from the transport packaging.
- Remove the transport packaging upward.
- Remove the remaining foam material.
- Using at least 2 people, lift the unit from the lower packaging element.

- Verify that the packaging contains the unit, applicators, power cord, User Manual, Quick Start Guide, and indicator discharge tube.

Inspection

Immediately upon unpacking the unit, perform the following steps:

- Verify the delivery documents to make sure that the delivery is complete.
- Check the external components and accessories for possible damage due to transport.

 **DANGER**

In case of damage from transport that could endanger personal safety, the unit must not be connected to the Mains Power Supply before inspection is complete.





SETUP

REQUIREMENTS FOR INSTALLATION

Before the unit can be installed and put into operation, certain requirements must be fulfilled in the building where the unit is to be operated.

 **WARNING**

- If the unit cannot be installed immediately after delivery, the unit and its external components or accessory elements must be stored in their original packaging in a dry place.
- Do not store or operate the unit in a dusty environment.

that are earthed or have a high capacity to earth must be prevented (e.g. heating pipes, water faucets, metal chairs, metal beds or other earthed devices).

- The unit must be set up so that the (normal) release of electromagnetic radiation during operation does not hinder the function of other devices or data media. The minimum distance to other devices or their power supplies or data transfer lines is 12 meters (see the Caution on [page 6](#) for more information). Please note that the radiation can easily pass walls, ceilings and floors.
- The room and the installation location must be large enough so that the unit can be operated from the front even if the electrodes are positioned inconveniently.

Requirements of the Installation Location

 **DANGER**

The unit must be installed so that there is no danger to the patient, the operator, or other persons. Therefore, you must read the Safety Instructions on [pages 4-11](#) and the following information.

Keep in mind the following:

- By selecting a suitable location for setting up the unit or by means of structural measures, contact during the treatment by the personnel or the patient with conductive materials





NOMENCLATURE

FRONT VIEW

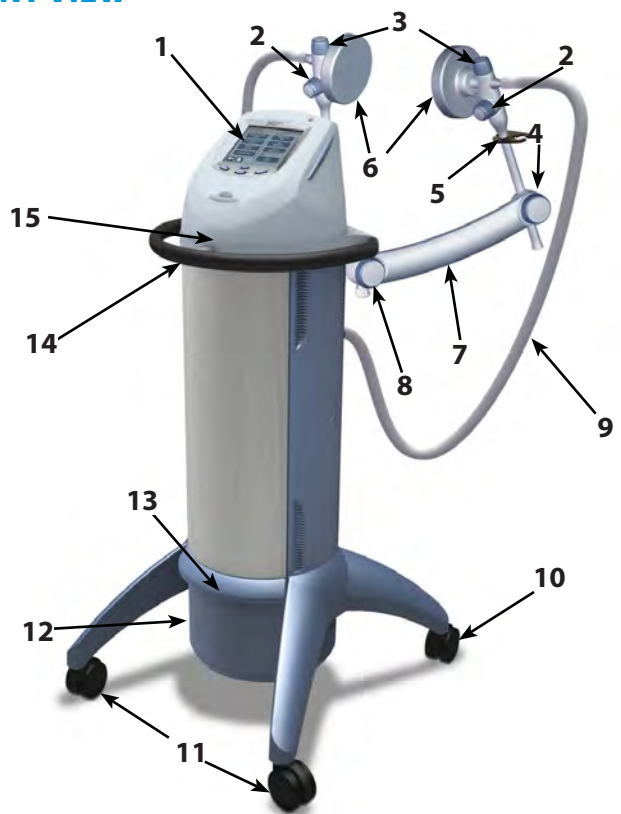

1. User Interface (see [page 30](#))
2. Arm Extender Lock Knobs
3. Electrode Lock Knobs
4. Front Handwheel
5. Arm Extenders
6. Capacitive Electrodes 120 mm
7. Electrode arm
8. Rear Handwheel
9. Electrode connection cable
10. Locking castor
11. Non locking castors
12. IEC Connector for Power Cord
13. Storage Bin
14. Grab Bar
15. Swivel Console





NOMENCLATURE

REAR VIEW

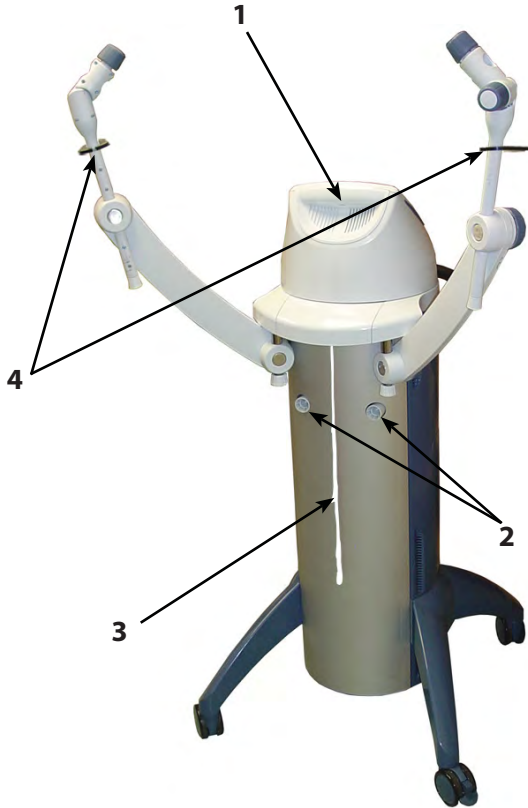

1. Expansion Port (for Service Use only)
2. Output Sockets
3. Patient Interrupt Cord
4. Cable Clips



NOMENCLATURE

USER INTERFACE

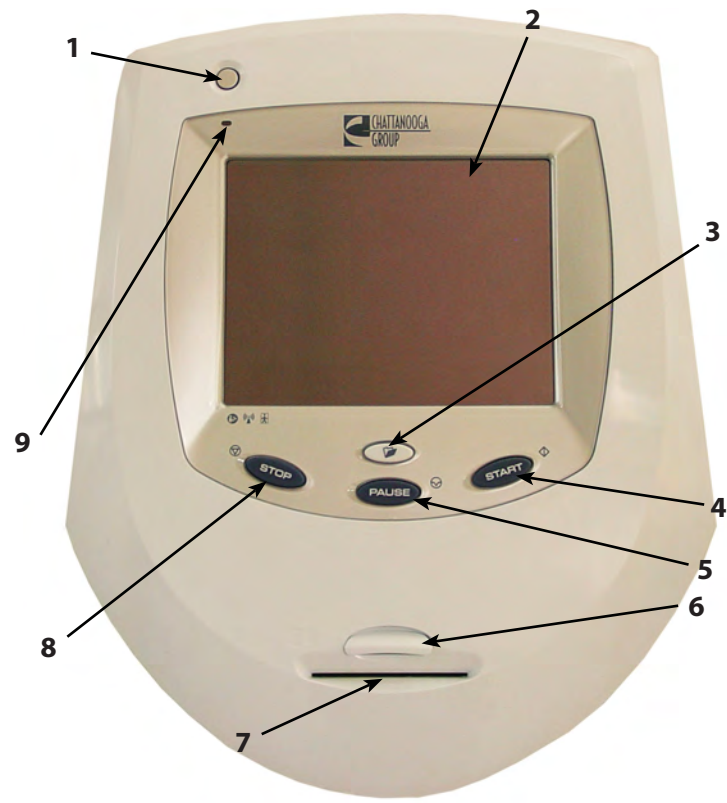







- 1. Power On/Off Button
- 2. Liquid Crystal Display (LCD) and Touch Screen
- 3. Clinical Resources Button
- 4. START Button
- 5. PAUSE Button
- 6. Multimedia Card (MMC) Port
- 7. Patient Data Card Port
- 8. STOP Button
- 9. Power LED











NOMENCLATURE

SOFTWARE SYMBOLS

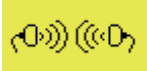
-  Display the Edit Treatment Screen
-  Up Arrow (Increase)
-  Down Arrow (Decrease)
-  Touch and Slide Left to Increase
Touch and Slide Right to Decrease
-  Back (Return to Previous Screen)
-  Display the Home Screen
-  Move the cursor to the left one space
-  Move the cursor to the right one space

-  Accept/Select (Parameters)
-  Cancel and Return to Previous Screen
-  Display Information
-  Change Text to Upper Case
-  Change Text to Lower Case
-  Shortwave Diathermy is being emitted
-  Pause
-  Unit is Tuning



NOMENCLATURE

ACCESSORIES



WARNING

Keep all electrodes, accessories, and their cords separated during treatment by using the cable clips located on the side of the arm extenders. Electrodes or their cords in contact with each other during treatment could result in improper stimulation, skin burns, or damage to the cord or electrode.

Capacitive Electrodes

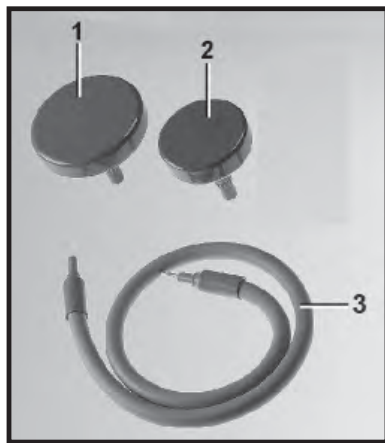

1. Capacitive Electrode 165 mm (6.5 in)
2. Capacitive Electrode 120 mm (4.7 in)
3. Electrode connection cable

Flexible Rubber Electrodes

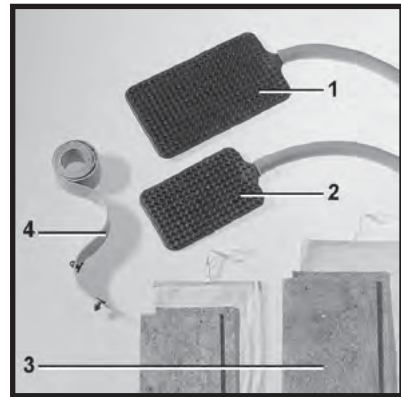

1. Flexible Rubber Electrode 250 x 145 mm (9.8 x 5.7 in)
2. Flexible Rubber Electrode 180 x 120 mm (7.1 x 4.7 in)
3. Felt layer with linen bag for 1 and 2
4. Perforated rubber band with 2 buttons



NOMENCLATURE

ACCESSORIES (CONTINUED)

Monode (Drum) Electrode

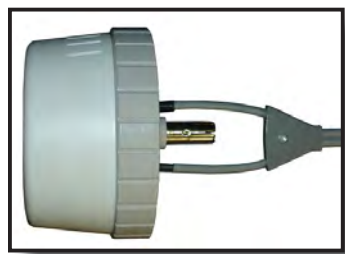

14 cm (5.5 in) round Monode (Drum) Electrode with cable

Diplode Electrodes

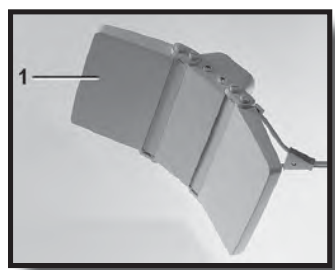

18 x 39 cm (7 x 15.4 in) curved rectangular Diplode Electrode with cable

Indicator Discharge Tube

To verify that shortwave diathermy energy is actually being transmitted, this small, fluorescent tube illuminates when it's held between the capacitive or flexible rubber electrodes, or near the monode and diplode (assuming a therapy session is in progress).

NOTE: The indicator discharge tube will not illuminate if the output power is at a low setting.



SPECIFICATIONS

UNIT SPECIFICATIONS

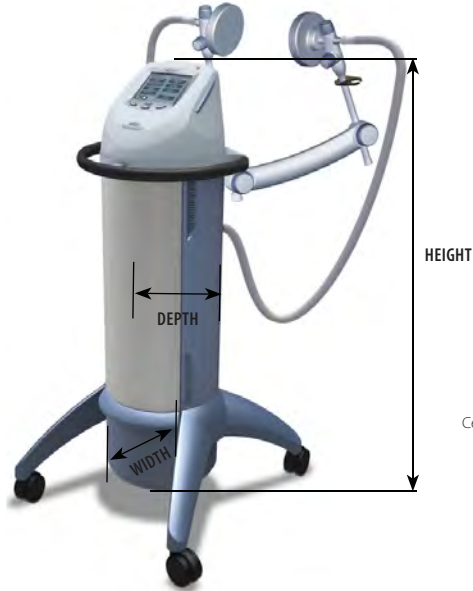

1604



Certified to CAN/CSA STD C22.2 No. 601.1

1602



0413

Ambient temperature+10 °C to 40 °C (50 °F to 104 °F)
 Relative Humidity 30% to 75%
 Air Pressure700 hPa to 1060 hPa
 Power Consumption 500 VA
 Input..... 120-240 V ~, 50/60 Hz (Model 1602)
 120 V ~, 60 Hz (Model 1604)
 Output Frequency 27.12 MHz ± 0.6%
 ModePulsed or Continuous
 Output Power..... 0 - 100 W in continuous mode at 50 ohms
0 - 200 W in pulsed modes at 50 ohms
 Power Increment Settings......5 W
 Power Indicationmaximum and average power
 Pulse Width 20 - 400 µsec in 20 µsec increments
 Pulse Frequencies 10 - 800 Hz in 10 Hz increments
 Treatment Duration 1 - 60 minutes in 1 minute increments
 Electrical ClassCLASS I
 Electrical Type (Degree of Protection)..... TYPE BF 
 Regulatory Risk ClassIIb according to MDD 93/42/EEC

* without electrodes, electrode arm, and electrode cables

Operating Data and Ratings

Width* 420 mm (16.5")
 Depth* 410 mm (16.14")
 Height* 1143 mm (45")
 Standard Weight (with diplode electrode) 27.22 kg (60 lbs)





SPECIFICATIONS

UNIT SPECIFICATIONS (CONTINUED)

Software

The software is developed and provided by Chattanooga Group. ©2009 Encore Medical, L.P. and its affiliates, Austin, Texas, USA.

To view the version of the software, press the Unit Settings button on the Clinical Resources screen. The version number of the software appears at the top of the screen.

Transport and Storage Conditions

- Ambient temperature-40 °C to 70 °C (-40 °F to 158 °F)
- Relative Humidity 30% to 75%
- Air Pressure50 kPa to 1060 kPa

Safety

The Intellect Shortwave 100 has been designed to meet the requirements of IEC/EN 60601-1, 60601-2-3, 60601-1-2, and 60601-1-4.

DANGER

In order to prevent excessive warming of tissue, the maximum and average output power must not be exceeded.





SPECIFICATIONS

APPLICATOR SPECIFICATIONS

Pay special attention to the list of contraindications. Refer to "Safety Instructions" on [pages 5-11](#), "Contraindications" on [pages 20-23](#), "Additional Precautions" on [pages 24-25](#), and "Personal Safety" on [pages 12-13](#).





DESCRIPTION OF DEVICE MARKINGS

The markings on the Intellect Shortwave 100 system are your assurance of its conformity to the highest applicable standards of medical equipment safety and electromagnetic compatibility. One or more of the following markings may appear on the device:

Meets Directive 93 /42 /EEC, Complies with 21CFR 1040.10 &1040.11 IEC/UL/EN: IEC/EN 60601-1, 60601-2-3, 60601-1-2, and 60601-1-4

Electromedical equipment, Canadian Electrical Code. Part II: Safety standards for Electrical Equipment Risk Class I. Listed by Intertek Group, PLC with respect to electric shock, fire and mechanical hazards only in accordance with UL 60601-1, and CAN/CSA C22.2 No. 601.1-M90 w/Amd 2.

Refer to Instruction Manual/Booklet

Type BF Equipment

Council Directive 2002/96/EC concerning Waste Electrical and Electronic Equipment (WEEE). Indicates a requirement not to dispose of WEEE as municipal waste. Contact your local distributor for information regarding disposal of the unit and accessories.



Adjustments or replacement of components may result in the equipment failing to meet the requirements for interference suppression.



Non-ionizing Electromagnetic Radiation. Text with a "Non-ionizing Electromagnetic Radiation" indicator informs the user of possible hazards resulting from elevated, potentially dangerous, levels of non-ionizing radiation.



OPERATION

DESCRIPTION OF FUNCTIONS

Introduction

The Intellect Shortwave 100 unit can produce dielectric warming by means of electric or electromagnetic fields of varying intensity in essentially any region of the body and can therefore be used for a wide variety of applications.

Treatments can be carried out using either the capacitive field or the inductive field method. In the capacitive field method, the body part to be treated is within the electric field between two capacitive electrodes. The “radiation” produces a warming of the body part located within the induction field. Fat layers are warmed considerably more than muscle tissue. When applying the inductive field method, the body part is within a magnetic field, which especially warms tissue containing liquid located near the surface, such as muscles.

Applications

The shortwave diathermy unit is suitable for nearly all heat therapy processes for use in clinics and private practices. Classical therapy applications can be conducted with the inductive field and capacitive field methods in continuous or pulsed mode.

The application of high-frequency energy in heat therapy has the advantage of greater depth penetration as opposed to simpler methods, such as packs, baths, infrared light, and heat cushions.

The endogenous heat that is formed triggers a series of physiological processes, producing a spasmolytic effect on muscles, tendons, and other structures containing connective tissue, increasing the cell metabolism and the enzyme reaction speed and stimulating perfusion in the treated zone.

The capability of applying the high-frequency energy in short, intense pulses (pulsed mode) can further increase the depth effectiveness, especially the stimulation of perfusion, while the heat generation is hardly felt in the skin, which is more sensitive to heat.

The applications for the high-frequency therapy are diverse. This therapy is especially effective in treating rheumatic disorders of the joints and muscles, inflammatory disorders of the respiratory organs, the kidneys and bile ducts, and all disorders due to insufficient perfusion. The pulsed mode is advantageous in the treatment of acute conditions.

Intellect Shortwave 100 units are therefore used for a wide range of applications in hospitals and in private practices by doctors and physiotherapists.



DESCRIPTION OF FUNCTIONS (CONTINUED)

Shortwave Diathermy in the Capacitive (Dielectric) Field

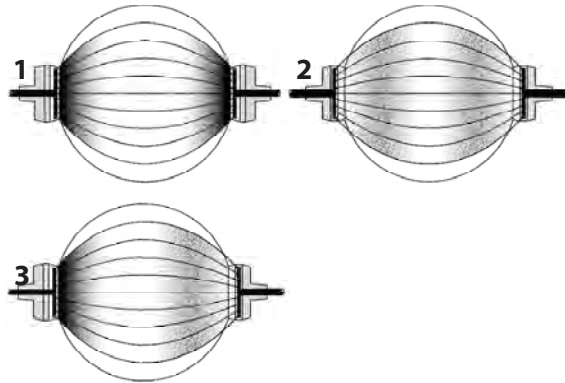

1. Heat distribution with a small Electrode-Skin Distance (ESD)
2. Heat distribution with a large Electrode-Skin Distance (ESD)
3. Heat distribution with an unequal Electrode-Skin Distance (ESD)

With the capacitive field method, the body part being treated is located in the high-frequency electric field between two insulated electrodes. The body and the electrodes together form a capacitor. This causes heat to be generated in the entire treatment field located between the electrodes.

With the capacitive method, fat tissue is warmed more effectively than muscle tissue.

Capacitive electrodes and flexible rubber electrodes are used for the capacitive method.

An adjusting device on the capacitive electrodes or layers of felt with the flexible rubber electrodes can be used to achieve different Electrode-Skin Distances (ESD).

 **DANGER**

The Electrode-Skin Distance (ESD) must be small for surface warming and large for depth warming. A larger Electrode-Skin Distance (ESD) is necessary for patients with a thick layer of subcutaneous fat in order to achieve the necessary warming of deep-lying tissue.



OPERATION

DESCRIPTION OF FUNCTIONS (CONTINUED)

Shortwave Diathermy in the Inductive Field

The inductive field method produces high-frequency electric currents within the body tissue by means of induction. The high-frequency circuit of closed currents occurring in the tissue as a result of induction are referred to as eddy currents. The density of these eddy currents, which is important for the warming effect, is proportional to the electrical conductivity of the tissue. At the same field intensity, therefore, tissue with better conductivity, such as muscles and inner organs, are warmed more than fat tissue. The danger of excessive heating of the outer layers of tissue is therefore significantly reduced, while effective warming down into the muscles is primary.

Two different inductive electrodes are available:

- Monode (Drum) Electrode for treatment of mid-sized areas.
- Diplode for treatment of large areas and for treatment of suitable body parts that can be warmed from three sides at the same time.

With the inductive field electrodes, the perception of warming is delayed. It is recommended to remain below the desired power output at the beginning of the treatment and then to increase the power in increments.



WARNING

Inductive field electrodes that are operated without a patient could be destroyed due to overheating.



OPERATION

INSTALLING THE APPLICATORS

Installing the Capacitive Electrodes



1. Remove the cable from the electrode.



2. Loosen the Electrode Lock Knob by turning it counter clockwise.



3. Push the electrode rod through the hole in the extension arm until the electrode rod is barely seen on the other side of the hole.



4. Tighten the Electrode Lock Knob by turning it clockwise.





INSTALLING THE APPLICATORS (CONTINUED)



5. Re-attach the cable to the electrode.



6. Fit the cord of the electrode into the cable clip on the outside of the arm.



7. Plug the connector of the electrode cable into the output socket on the rear panel.
8. Repeat steps 1-7 for the additional electrode.



WARNING

- Do not cross cables.
- To remove the cable from the applicator, make certain the power is off. While the electrode applicator is being supported by the electrode arm, hold the electrode while removing the cable to prevent the electrode from dropping to the floor.
- Tighten arms so that they do not move during therapy.
- Observe the patient and the position of the arms at all times during therapy.
- Inform the patient that the arms are not supposed to move during therapy.
- Before using the unit, verify the patient is not in contact with the unit, the electrode connection cable, the electrodes, or other devices or metal objects.



OPERATION

INSTALLING THE APPLICATORS (CONTINUED)

Installing the Monode (Drum) and Diplode Electrodes

The Monode and Diplode are installed identically. However, only the monode is illustrated in this section.



1. Remove the black, plastic retaining T nut from the sleeve by turning it counter clockwise.



2. Slide the sleeve off the metal mounting post of the monode.



3. Remove the Electrode Lock Knob by turning it counter clockwise.



4. Push the sleeve completely through the hole in the extension arm.



OPERATION

INSTALLING THE APPLICATORS (CONTINUED)



5. Reattach and tighten the Electrode Lock Knob by turning it clockwise until it is snug.

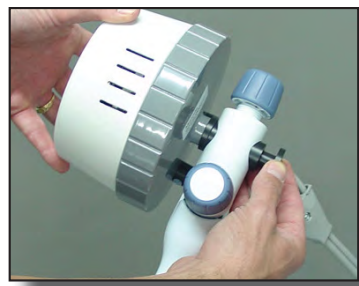

7. Re-attach and tighten the black, plastic retaining T nut onto the sleeve by turning it clockwise.

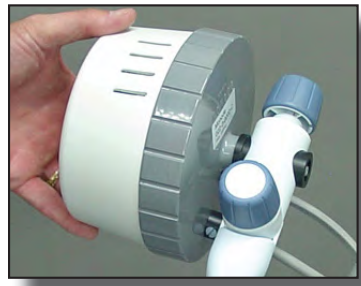

6. Push the metal mounting post of the monode completely through the sleeve.



8. Fit the cord of the monode into the cable clip on the outside of the arm.





OPERATION

INSTALLING THE APPLICATORS (CONTINUED)



9. Plug the connectors of the monode cable into the output sockets on the rear panel.

Installing the Flexible Rubber Electrodes

Installation of the Flexible Rubber electrodes is only necessary immediately before therapy. For more information, refer to "Using the Flexible Rubber Electrodes" on [page 76](#).

WARNING

- To remove the cable from the applicator, make certain the power is off. While the electrode applicator is being supported by the electrode arm, hold the electrode while removing the cable to prevent the electrode from dropping to the floor.
- Tighten arms so that they do not move during therapy.
- Observe the patient and the position of the arms at all times during therapy.
- Inform the patient that the arms are not supposed to move during therapy.
- Before using the unit, verify the patient is not in contact with the unit, the electrode connection cable, the electrodes, or other devices or metal objects.





OPERATION

PREPARING THE UNIT FOR THERAPY

The unit has been completely assembled in the factory and is ready for use except for connection of the electrodes and the power cord.

Proceed as follows in order to prepare the unit for operation:

- Make sure that the voltage rating on the serial decal conforms to the system voltage of the building.
- Insert the required electrodes into the recesses at the end of the electrode arms and fasten the electrodes with the locking screws. See [pages 41-42](#) for more information on installing the electrodes.
- Plug the electrode connection cable into the socket on the back of the unit. Attach the connecting cable in the cable holders on the electrode arms.
- Check the condition of the housing and the insulation of the electrodes, electrode connection cable and the power supply cable. Also make sure that the cables have been routed correctly.
- Insert the power cord plug into an earthed socket outlet.

 **DANGER**

The unit and the electrodes must be positioned so that there is no danger of personal injury. Therefore, you must read and observe the safety instructions and the list of contraindications before putting the unit into operation.

 **WARNING**

Make certain that the unit is electrically earthed by connecting only to an earthed electrical service receptacle, conforming to the applicable national and local electrical codes.





OPERATION

PREPARING THE PATIENT FOR THERAPY

Before applying shortwave diathermy to the patient, you must first prepare the patient's skin. By properly preparing the patient's skin for shortwave diathermy, you will allow more energy to reach the targeted areas and reduce the risk of skin irritation.

To prepare the patient's skin for shortwave diathermy, do the following:

1. Thoroughly wash the skin on which you intend to administer shortwave diathermy therapy with mild soap and water or alcohol wipe.
2. Dry the skin thoroughly.



Before using the unit, verify the patient is not in contact with the unit, the electrode connection cable, the electrodes, or other devices or metal objects.





OPERATION

BASIC OPERATION



1. Connect the male end of the power supply cord to an appropriate electrical outlet.



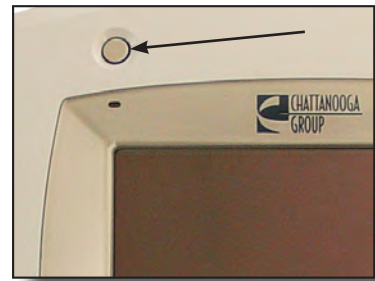

2. Connect the female end of the power supply cord into the IEC connector on the side of the unit.



3. Press the Power On/Off button or touch the LCD. The following occurs when the Power On/Off button is pressed or the LCD is touched:

- three quick beeps sound
- the blue LED illuminates
- the Home Screen displays.

The Operator Interface consists of buttons with a touch screen liquid crystal display (LCD). The operator is able to view parameter options on the display and make selections by pressing the buttons directly on the LCD. The LCD provides continuous information during the treatments concerning dosage and elapsed time. Parameters are adjusted using the  and  buttons. The output can be stopped by the user by pressing the PAUSE or STOP buttons located on the Operator Interface. The patient can stop the therapy treatment at any time by pulling the cord of the patient interrupt cord.







OPERATION

STARTING THERAPY

The Intellect Shortwave 100 offers the following methods from which you can begin a treatment session:

- Thermal Dosimetry (page 51)
- Quick Link Indications (page 52)
- Clinical Protocols (page 56)
- User Protocols (page 58)
- Home screen (page 52)
- Patient Card (page 65)



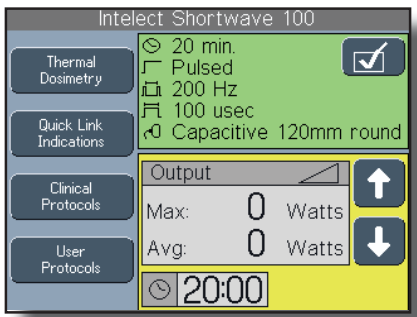

Home Screen

The Home screen serves as the main treatment screen. After the treatment parameters have been selected, you may increase or decrease the output power (in watts) during therapy on the Home screen by using the  and  buttons.

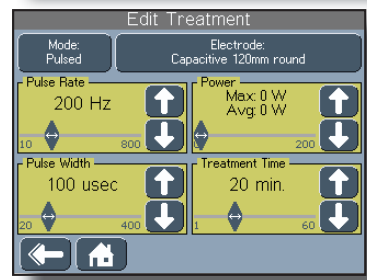
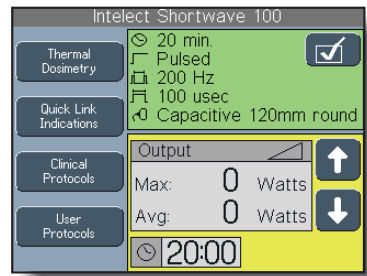

Edit Treatment Screen



1. On the Home Screen, press the  button. The Edit Treatment screen displays.
2. Increase the parameters on the Edit Treatment screen by pressing the  button.
3. Decrease the parameters by pressing the  button.
4. You may also increase and decrease parameters by pressing and sliding the  button either left or right.





OPERATION

STARTING THERAPY (CONTINUED)

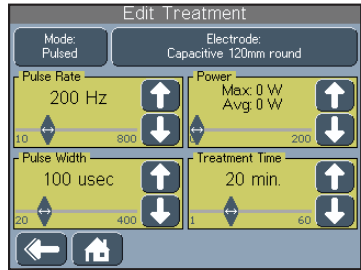

5. Press the Mode button to select either Pulsed or Continuous.

NOTE: Pulse Rate and Pulse Width parameters are not available when the Continuous mode is selected and the Diplode or Monode electrodes are selected.

6. Press the button to return to the previous screen.
7. Press the button to return to the Home screen.

Electrode Screen

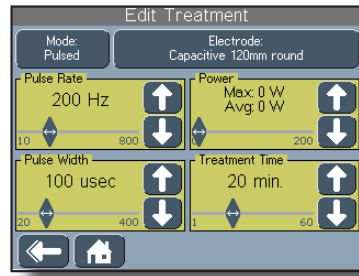

2. On the Edit Treatment screen, press the Electrode button at the top of the screen. The Select Electrode screen displays.
2. Press the electrode to highlight it, or press the and buttons to scroll through a list of the available electrodes.
3. Press the button to accept the highlighted selection and return to the Edit Treatment screen.
4. Press the button to return to the previous screen.





OPERATION

STARTING THERAPY (CONTINUED)

- 5. Press the  button to return to the Home screen.

Thermal Dosimetry

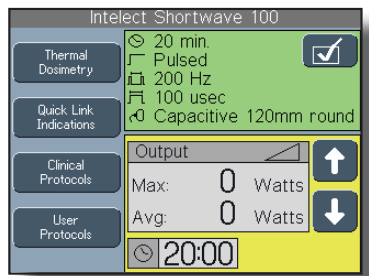

- 1. On the Home screen, press the Thermal Dosimetry button. The Select Thermal Dosimetry screen displays.

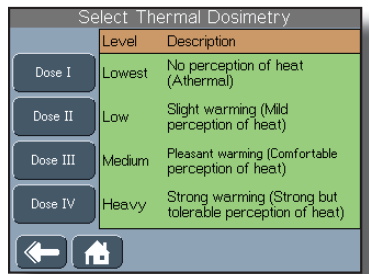

- 2. Press the button next to the appropriate dosage and applicable indication.

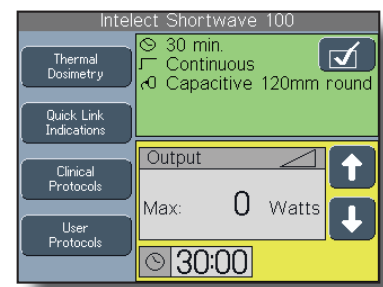

You are returned to the Home screen with the parameters of the indication displayed to begin treatment.





OPERATION

BASIC OPERATION (CONTINUED)

Quick Link Indications

By pressing the Quick Link Indications button on the Home screen, you can access specific pre-programmed indications, for general reference only, which aid in selecting the proper output and electrode placement for particular indicated patient syndrome diagnoses.

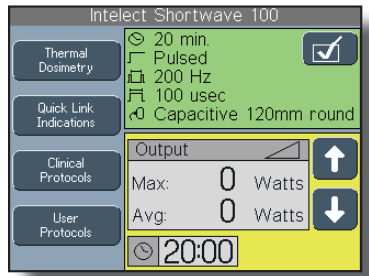

1. On the Home screen, press the Quick Link Indications button. The Quick Link Indications screen displays.

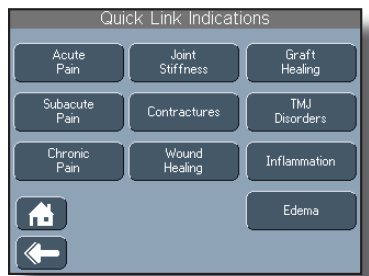

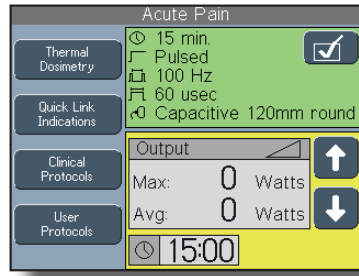

2. Click one of the buttons on the Quick Link Indications screen (depending on the needs and symptoms of the patient). The Home screen displays with the pre-set parameters for the indication you selected displays to begin

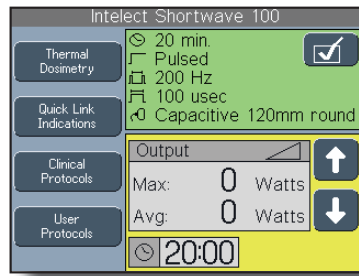

treatment. For example, you may have pressed the Acute Pain button which would cause the Acute Pain screen to display.

Starting Therapy from the Home Screen



1. On the Home screen, press the  and  buttons to set the appropriate output power (in watts) for therapy.

NOTE: You can only set the treatment time on the Edit Treatment screen.





OPERATION

BASIC OPERATION (CONTINUED)

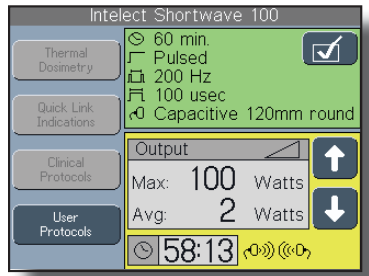

2. Press the START button on the User Interface to begin treatment. When the START button is pressed:
 - a beep sounds
 - the unit begins auto tuning (clicking can be heard)
 - the unit begins emitting shortwave diathermy energy
 - the timer counts down
 - the  icon displays.

Indicator Discharge Tube

To verify that shortwave energy is actually being transmitted, this small, fluorescent tube illuminates when it's held between the rigid condenser electrodes and the flexible rubber electrodes (assuming a therapy session is in progress).

NOTE: The indicator discharge tube will not illuminate if the output power is at a low setting.





OPERATION

STOPPING, PAUSING, AND COMPLETING THERAPY

Stopping Therapy Using the STOP Button

To stop shortwave diathermy, press the STOP button on the User Interface. When the STOP button is pressed:

- the applicator stops emitting shortwave diathermy energy.
- the message "**Treatment has been stopped by user. Do you want to save treatment to a Patient Card?**"
- the unit sounds long tones until you press a button on the message window.

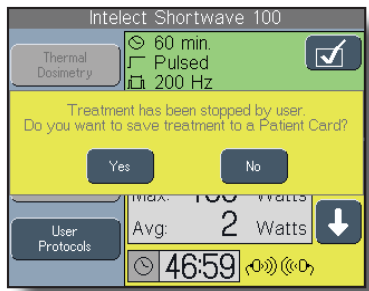

1. If you choose to save the current parameters to a patient card, press the Yes button and follow the instructions on [page 68](#), beginning with step 2.
2. If you do not want to save the current parameters, press the No button. You are returned to the Home screen.

Stopping Therapy Using the Patient Interrupt Cord

If the therapy is stopped by pulling the cord of the Patient Interrupt Cord:

- the applicator stops emitting shortwave diathermy energy
- The  (pause) symbol displays and blinks
- the message "**Treatment has been stopped by the patient. Press any button to continue.**"

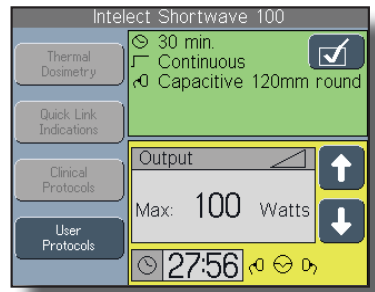

1. Press any button on the unit to acknowledge the message. The treatment can be resumed by pressing the Pause or Start buttons.





OPERATION

STOPPING, PAUSING, AND COMPLETING THERAPY

Pausing Therapy

The therapy can be interrupted at any time by pressing the PAUSE button on the User Interface. When the PAUSE button is pressed, the following occurs:

- the applicator stops emitting shortwave diathermy energy
- The  (pause) symbol displays and blinks

To resume therapy, press the PAUSE button on the User Interface.

Completing the Therapy Session

When the treatment time expires:

- the applicator stops emitting shortwave diathermy energy
- the message "*Treatment has completed. Do you want to save treatment to a Patient Card?*"
- the unit sounds long tones until you press a button on the message window.

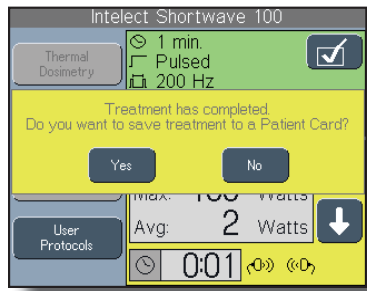

1. If you choose to save the current parameters to a patient card, press the Yes button and follow the instructions on [page 68](#), beginning with step 2.
2. If you do not want to save the current parameters, press the No button. You are returned to the Home screen.





OPERATION



USING CLINICAL PROTOCOLS

The indications contained in this section are to be used only as guidelines. Each patient should be individually assessed to determine the appropriateness of the parameter setting prior to use.



1. Insert the MMC labeled "SWD Clinical Resource Library" into the MMC port.

2. On the Home screen, press the Clinical Protocols button. The Clinical Protocols screen displays.

3. Press the specific body area on the front or back image to select the desired body area to treat. The screen unique to the area of the body you pressed displays.

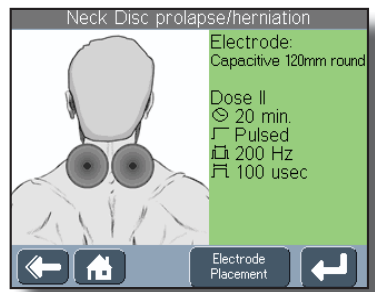
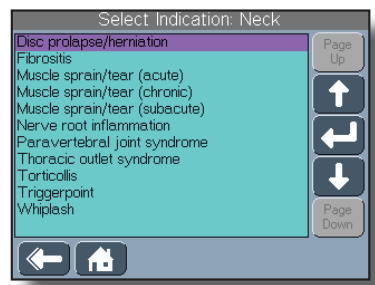
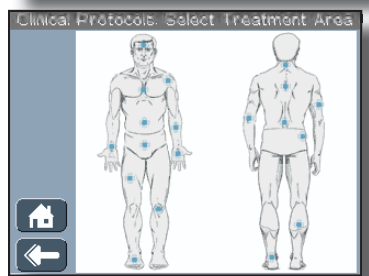
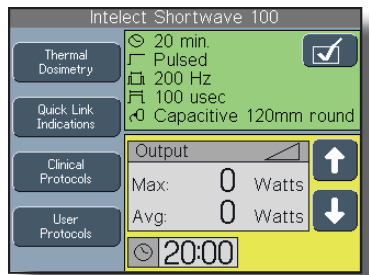
4. If applicable, press the  and  buttons to scroll through the pages of protocols.



5. Press the protocol to highlight it, or press the  and  buttons to scroll through the list.

6. Press the  button to accept the highlighted selection. The suggested parameter and electrode screen displays.

7. To select this protocol and begin treatment, press the  button. The Home screen displays and you can begin treatment.

8. If you want to change the electrode placement (e.g. the recommended electrode does not match the electrode you are





OPERATION

USING CLINICAL PROTOCOLS (CONTINUED)

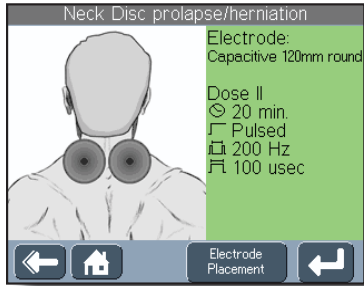

using), press the Electrode Placement button. The next Clinical Protocols screen displays.

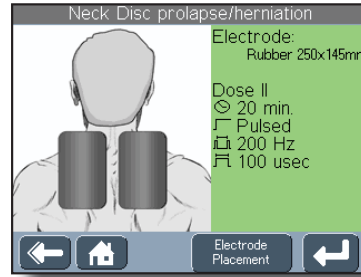

10. Press the button. The Home screen displays with the new parameters.

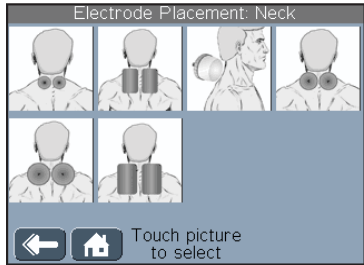

9. Press one of the electrode placement images to change electrode placement. The suggested parameter and electrode screen displays. Notice that the electrode details changed to match the new electrode placement image selection.

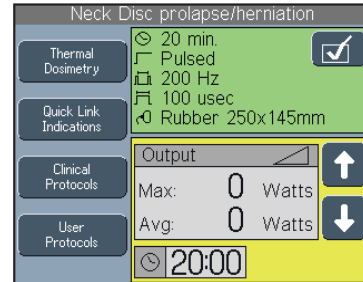

11. Press the and buttons to set the appropriate output power for treatment.

12. Press the EDIT button to change the parameters.

13. Press the START button to begin treatment.





OPERATION

RETRIEVING, DELETING, AND SAVING USER PROTOCOLS

The Intellect Shortwave 100 unit allows you to tailor a protocol according to the requirements of a patient. The treatment parameters selected at the home screen can be saved as a new user protocol or saved to replace a previously saved user protocol. You may create up to 200 user protocols.

Retrieving User Protocols

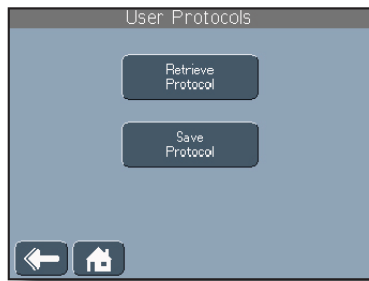

1. On the Home screen, press the User Protocols button. The User Protocols screen displays.

2. Press the Retrieve Protocol button. The Retrieve Protocol screen displays.

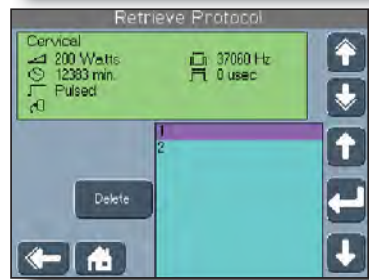

3. Press or scroll to the desired user protocol to view the treatment parameters.

4. Press  to select the highlighted protocol. You are returned to the Home screen to begin treatment.

Deleting User Protocols

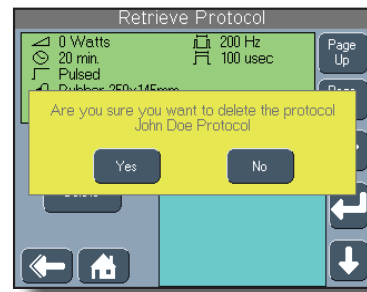

1. To delete the highlighted user protocol, press the Delete button on the Retrieve Protocol screen. A message displays to verify the deletion.

2. Press the Yes button to delete the user protocol. You are returned to the Retrieve Protocol screen.

NOTE: If you press Yes, the user protocol name and parameters will be permanently removed from the unit.





OPERATION

RETRIEVING, DELETING, AND SAVING USER PROTOCOLS (CONTINUED)

- 3. Press the No button to keep the user protocol and return to the Retrieve Protocol screen.

Saving New User Protocols

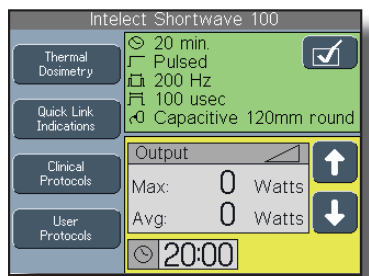

- 1. Set up treatment parameters by completing the steps listed in "Starting Therapy" on [pages 49-51](#), but do not press the START button.

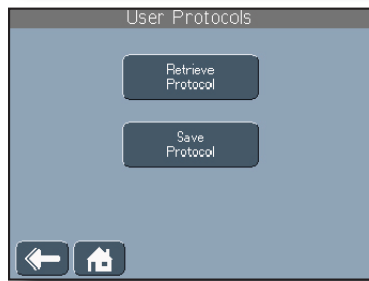

- 2. On the Home screen, press the User Protocols button. The User Protocols screen displays.
- 3. Press Save Protocol. The Save Protocol screen displays.



- 4. To create a name for the new protocol, press the Save Protocol as a New Name button. The Keyboard screen displays.



- 5. Type the name of the new protocol. The name of the new protocol can be up to 25 alpha-numeric characters.





OPERATION

RETRIEVING, DELETING, AND SAVING USER PROTOCOLS (CONTINUED)

6. Press the button to save the name of the protocol. A message displays briefly to confirm the protocol was saved. The Home screen displays the parameters of the user protocol you just saved.

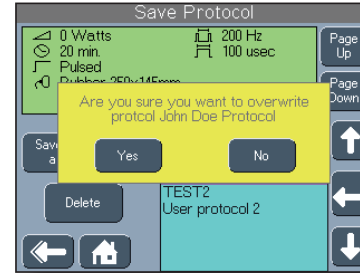

2. Press the button to save the new treatment parameters. A message displays to confirm the overwriting of the old parameters. If you press Yes, a message displays briefly to confirm the protocol was saved and the Home screen displays the parameters of the user protocol you just saved. If you press No, you are returned to the Save Protocol screen.

Editing Existing User Protocols



1. To edit the treatment parameters of a previously saved user protocol, press to highlight, or scroll through the list of user protocols and highlight the appropriate user protocol.





OPERATION

USING CLINICAL RESOURCES - EDUCATIONAL LIBRARY

The Educational Library can be accessed by pressing the button with the  icon (Clinical Resources button) located below the touch screen display. The Clinical Resources screen allows you access to the Educational Library, Patient Card management, and Utilities screens.

Anatomical Graphics Library

The Anatomical Graphics Library features graphical images of the human anatomy and pathological conditions for which shortwave diathermy is used. To access the Anatomical Graphics Library, make sure the MMC labeled "SWD Clinical Resource Library" is in the MMC port and do the following:

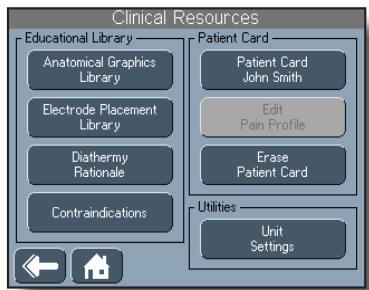

1. On the Clinical Resources screen, press the Anatomical Graphics Library button. The Anatomical Graphical Library screen displays.

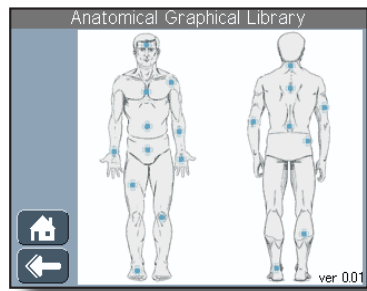

2. Press the button of the body area on which you intend to administer therapy. The screen that corresponds to the body area you selected displays. For example, you may have pressed the back of the neck which would cause the Neck: Page 1 of 2 screen to display.

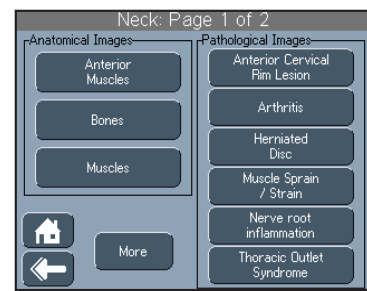



3. If available, press the  icon to display additional pathological images.



OPERATION

USING CLINICAL RESOURCES - EDUCATIONAL LIBRARY (CONTINUED)

4. Press a button on the left side of the screen (Anatomical Images) to display a list of either muscles or bones that make up the area.
5. Press the  button to return to the previous screen.
6. Press a button on the right side of the screen (Pathological Images) to display an illustration of a common disorder associated with the body area.
7. Press the  button to return to the previous screen.

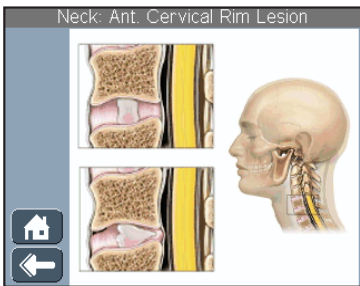
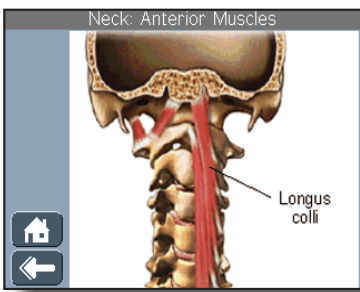

Electrode Placement Library

The Electrode Placement Library serves as a guideline for the placement of electrodes for shortwave diathermy.

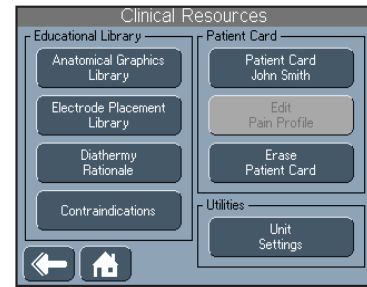

1. On the Clinical Resources screen, press the Electrode Placement Library button. The Select Treatment Area screen displays.

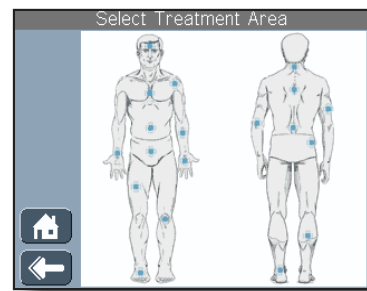

2. Press the body area on which you intend to administer therapy. The screen that corresponds to the body area you selected displays. For example, if you press the back of the neck, the Electrode Placement: Neck displays.

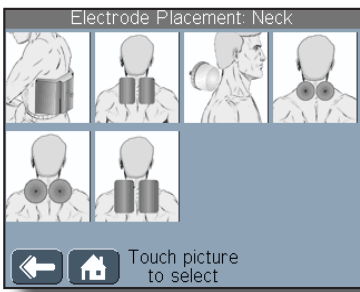

OPERATION

USING CLINICAL RESOURCES - EDUCATIONAL LIBRARY (CONTINUED)

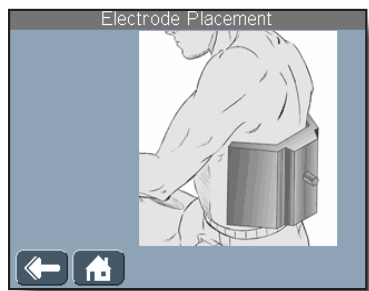

3. Press one of the electrode placement thumbnails to view the entire picture of the electrode placement. The Electrode Placement screen displays.



4. Press the  button to return to the previous screen.
5. Press the  button to return to the Home screen.

USING CLINICAL RESOURCES - EDUCATIONAL LIBRARY (CONTINUED)



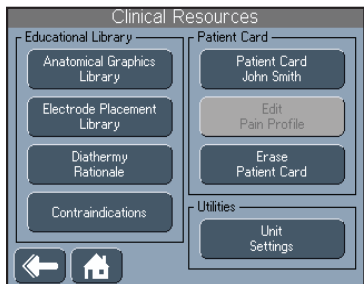

Diathermy Rationale

Pressing the Diathermy Rationale button displays an overview of shortwave diathermy, a list of available treatment options, and a synopsis of the available parameters.

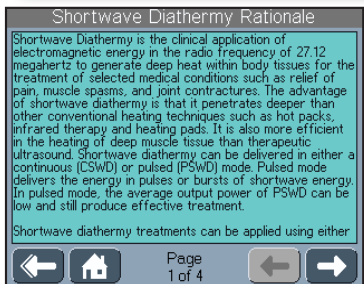

1. On the Clinical Resources screen, press the Diathermy Rationale button. The Shortwave Diathermy Rationale screen displays.



2. Press the  and  buttons to scroll through the information.
3. Press the  button to return to the previous screen.
4. Press the  button to return to the Home screen.



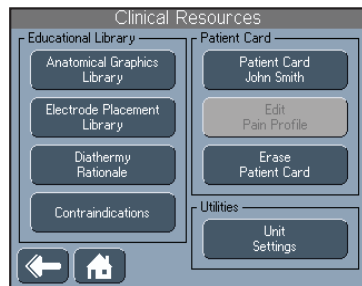

Contraindications

Pressing the Contraindications button displays a list of conditions for which shortwave diathermy is contraindicated.

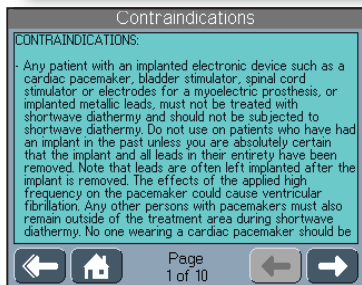

1. On the Clinical Resources screen, press the Contraindications button. The Contraindications screen displays.



2. Press the  and  buttons to scroll through the information.
3. Press the  button to return to the previous screen.
4. Press the  button to return to the Home screen.





OPERATION

USING CLINICAL RESOURCES - PATIENT CARD

The Patient Card buttons serve to manage the information stored on a patient's data card.

NOTE: This button is only active when a patient card is inserted into the patient card port on the device.

Viewing and Retrieving Treatments from the Patient Card

Press the Patient Card button to access the patient treatment data stored on the patient card.



1. On the Clinical Resources screen, press the Patient Card button. The Patient Card screen displays.

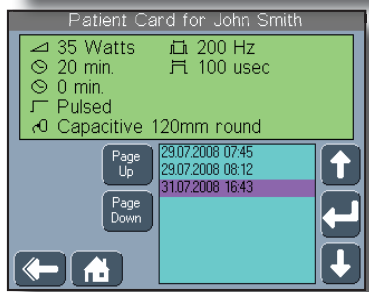

2. Press the and buttons to scroll through the treatment sessions. The treatment parameters for the highlighted treatment display at the top of the screen.

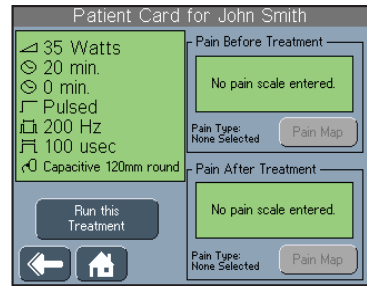

3. Press the and buttons if the number of treatment sessions extend beyond one page.

4. Press the button to select the treatment session. The treatment parameter screen displays.

5. Review the parameters of the treatment session.

6. Press the Run this Treatment button to begin treatment.



USING CLINICAL RESOURCES - PATIENT CARD (CONTINUED)

Edit Pain Profile

The Edit Pain Profile button allows access to the screen for pain information to be saved to the patient card while a therapy session is in progress. This information includes:

- Pain Scale before treatment
- Pain Scale after treatment
- Pain Type before treatment
- Pain Type after treatment
- Pain Map before treatment
- Pain Map after treatment
- Treatment Area

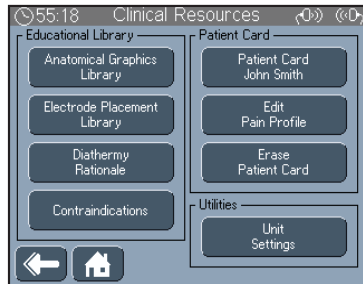

1. On the Clinical Resources screen, press the Edit Pain Profile button. The Edit Pain Profile screen displays.

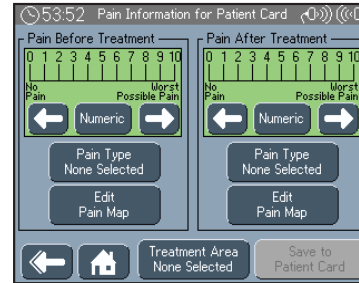

2. In the Pain Before Treatment section, press to select either a Numeric or Visual pain scale.
3. Press the ← button to decrease the amount of pain on the scale.
4. Press the → button to increase the amount of pain on the scale.
5. Press the Pain Type button. The Select Pain Type Before Treatment screen displays.
6. Press the pain type or use the ↑, ↓, and ← buttons to select the pain type. You are returned to the Edit Pain Profile screen with the new pain type selected.

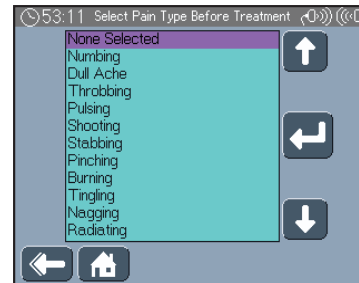



OPERATION

USING CLINICAL RESOURCES - PATIENT CARD (CONTINUED)

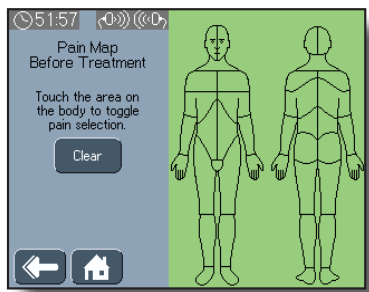

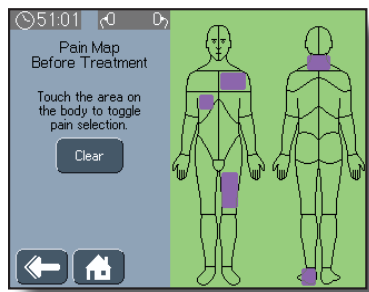

- 7. Press the Edit Pain Map button. The Pain Map Before Treatment screen displays.
- 8. Press the body area on which you intend to administer therapy. A purple shading displays in the areas you press.

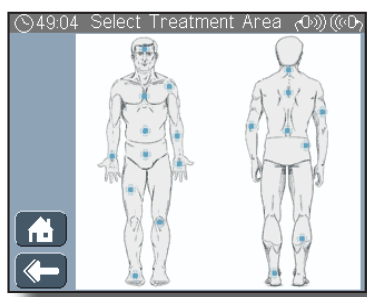

- 9. Press the Clear button to remove all the areas previously selected in the previous step.
- 10. In the Pain After Treatment section, repeat steps 2-9.
- 11. Press the Treatment Area screen. The Select Treatment Area screen displays.



- 12. Press the specific body area on the front or back image to select the desired body area to treat. You are returned to the Edit Pain Profile screen.
- 13. Press the Save to Patient Card to save the pain information to the patient's card.
- 14. Press the  button to return to the Clinical Resources screen.
- 15. Press the  button to return to the Home screen.





OPERATION

USING CLINICAL RESOURCES - PATIENT CARD (CONTINUED)

Saving Treatments to the Patient Card

If the treatment time expires during a treatment, or if you stop a treatment using the STOP button, the unit gives you the option of saving the treatment to a patient card.

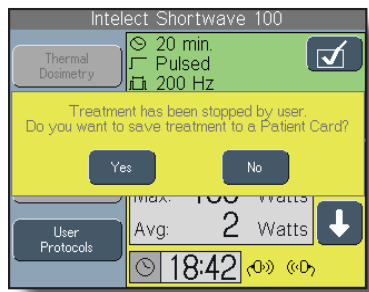

1. Press Yes when prompted to save to the patient card.
2. Follow steps 2-13 on [pages 66-67](#).

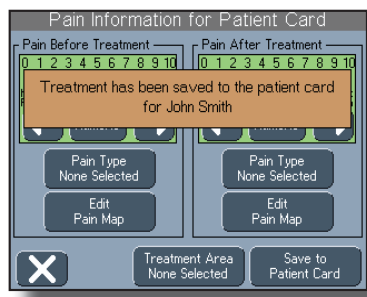

3. When you press the Save to Patient Card button, the message "**Treatment has been saved for (patient name)**" briefly displays.

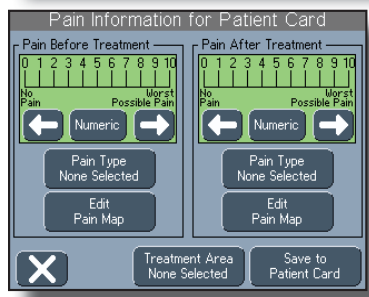



OPERATION

USING CLINICAL RESOURCES - PATIENT CARD (CONTINUED)

Erasing Patient Card

Use this button to remove all information on the Patient Card.

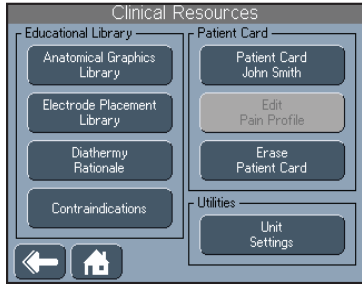

1. To delete all information on the Patient Card, insert the patient card to be erased into the Patient Data Card Port.
2. Press the Erase Patient Card button. A message displays to verify the deletion.

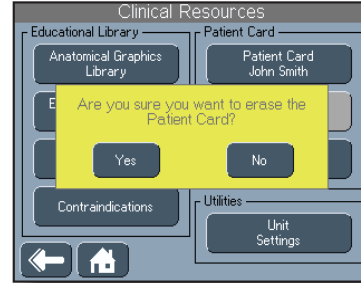

NOTE: By pressing the Yes button, you will permanently remove all data on the Patient Card.

You are returned to the Clinical Resources Screen.

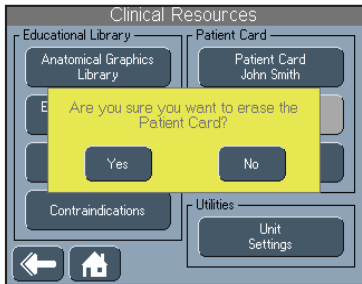

3. Press the No button if you do not want to erase all the information on the Patient Card. You are returned to the Clinical Resources screen.
4. Press the Yes button to erase all the information on the Patient Card.





OPERATION

USING CLINICAL RESOURCES - UNIT SETTINGS

To access the Unit Settings screen, press the Unit Settings button on the Clinical Resources screen. The version number of the software appears at the top of the screen.

Adding and Changing the Clinic Name

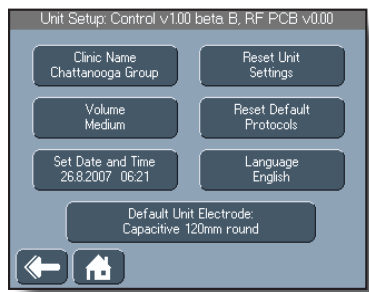

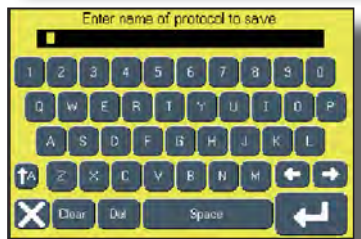

1. On the Clinical Resources screen, press the Unit Settings button. The Unit Setup screen displays.

2. On the Unit Setup screen, press the Clinic Name button. The Keyboard screen displays.



3. Type the name of the new protocol. The name of the protocol can be up to 25 alpha-numeric characters.

4. Press the  button to save the name of the protocol and return to the Unit Settings screen.

5. Press the  button to delete the new information you may have entered and return to the Unit Settings screen.

Increasing and Decreasing the Unit Volume

On the Unit Settings screen, press the Volume button repeatedly until the appropriate volume level displays. Each time you press the Volume button, a tone sounds at the volume level displayed. The volume will remain at the same level, even after powering the unit off.







OPERATION

USING CLINICAL RESOURCES - UNIT SETTINGS (CONTINUED)

Setting the Date and Time



1. On the Unit Settings screen, press the Set Date and Time button. The Set Date and Time screen displays.

2. Press the  and  buttons to set the year, month, day, hour, and minute.

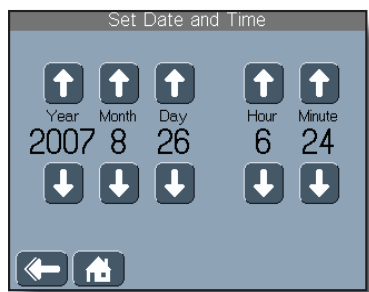

3. Press the  button to save the date and time settings you entered and return to the Unit Settings screen.

Resetting Unit Settings

This button resets settings such as the language, volume, and clinic name back to the original factory defaults.



1. On the Unit Settings screen, press the Reset Unit Settings button. The reset message displays.
2. Touch anywhere on the LCD. You are returned to the Unit Settings screen.

Resetting Default Protocols



1. To reset all user protocols to the default parameters, press the Reset Default Protocols button. A message displays to verify the reset.





OPERATION

USING CLINICAL RESOURCES - UNIT SETTINGS (CONTINUED)

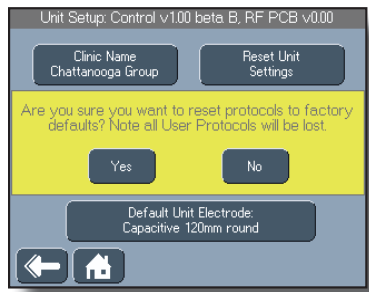

2. Press the No button if you do not reset all the user protocols to the default parameters. You are returned to the Unit Settings screen.
3. Press the Yes button to reset all user protocols to the default parameters.

NOTE: By pressing the Yes button, you will permanently remove user protocols you may have created.

You are returned to the Unit Settings Screen.

Changing Languages

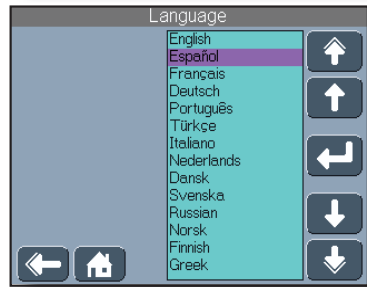

1. On the Unit Settings screen, press the Language button. The Language screen displays.
2. Press the and buttons to scroll through the pages of available languages.
3. Press the language to highlight it, or press the and buttons to scroll through the list.
4. Press the button to accept the highlighted selection. You are returned to the Unit Setup screen.

TOC





OPERATION

USING CLINICAL RESOURCES - UNIT SETTINGS (CONTINUED)

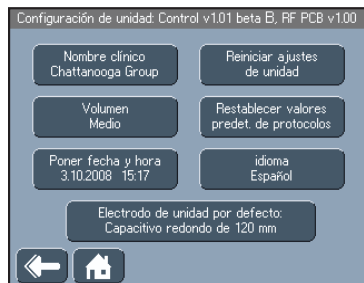

Notice that all the buttons are now in the new language you selected.



OPERATION

USING THE APPLICATORS

Using the Capacitive Electrodes



1. Loosen the front and rear handwheels and the Electrode Lock Knobs.



2. Using the arms and arm extenders, position the electrodes appropriately (see "Setting the Electrode-Skin Distance" on [page 81](#)).

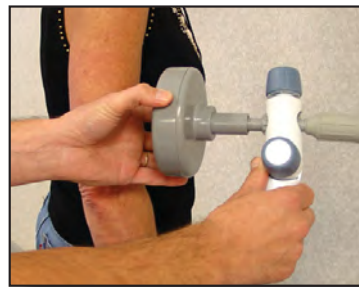

3. If necessary, adjust the spacing closer or farther away from the patient's skin sliding the shaft of the capacitive electrode in or out of the main electrode housing.



4. Tighten the front and rear handwheels and retaining sleeves to prevent movement of the arms and electrodes.



OPERATION

USING THE APPLICATORS (CONTINUED)



5. Depress the tabs of the castor locks to prevent the front wheels from moving.
6. To start therapy, continue with the section entitled "Starting Therapy" on [pages 49-51](#).



2. Using the arm and arm extender, position the Monode (or Diplode) over the treatment area appropriately (see "Setting the Electrode-Skin Distance" on [page 81](#)).

Using the Monode (Drum) and Diplode Electrodes



1. Loosen the front and rear handwheels and the Electrode Lock Knob of the arm that has the Inductive Applicator affixed to it.



3. Tighten the front and rear handwheels and the Electrode Lock Knob to prevent movement of the arm and Monode.





OPERATION

USING THE APPLICATORS (CONTINUED)



- 4. Depress the tabs of the castor locks to prevent the front wheels from moving.
- 5. To start therapy, continue with the section entitled "Starting Therapy" on [pages 49-51](#).



- 2. Depress the tabs of the castor locks to prevent the front wheels from moving.

Using the Flexible Rubber Electrodes



- 1. Plug the connector of the flexible rubber electrodes into the output socket on the rear panel.



- 3. Slide the felt spacers and flexible rubber electrode into the linen bag.

NOTE: Make certain to place the felt spacer on the side of bag that will be touching the patient's skin.





OPERATION

USING THE APPLICATORS (CONTINUED)

- 4. Depending on the type of therapy required, use the felt spacers to determine the appropriate space between the flexible rubber electrodes and the patient's skin. For more information, see "Setting the Electrode-Skin Distance" on [page 81](#).



- 6. Position the electrodes on both sides of the treatment area.



- 5. Tie the straps together on the linen bag to secure the flexible rubber electrodes.



- 7. Using the rubber strap, secure the electrodes and felt spacers on both sides of the treatment area.
- 8. To start therapy, continue with the section entitled "Starting Therapy" on [pages 49-51](#).





TREATMENT TIPS

Treatment times depend on the required depth and area of treatment. Shorter times should be used for areas of small tissue volume (e.g., hands, forearms, ankles, etc.). Longer times should be used for larger tissue volume (e.g., thighs, trunk, abdomen, etc.). Where possible, treatments should be twice daily. Otherwise, treatments should be at least every two days until the condition improves (normally between 6 to 10 treatments).

Should any discomfort occur, either during or after treatment, it may be due to excessive output for the condition being treated. In such cases, reduce the pulse rate by one setting and continue treatment. It is always better to reduce the pulse rate than the pulse width.

Positioning the Electrodes

Position the required electrodes on the part of the body to be treated according to the medical indication. Refer to the indications table at the end of this user manual and also make sure the electrodes are positioned so as to avoid overheating due to edge effects. The surfaces of the electrodes must be nearly parallel to the area being treated. It is possible, however, to use these edge effects for therapeutic purposes.

NOTE: If such an effect is expressly desired, the dosage must be controlled very carefully.

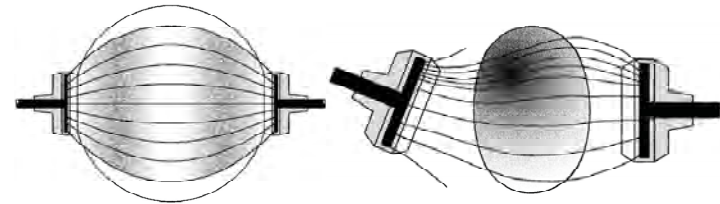

Correct

Incorrect

Positioning of Electrodes – Edge Effect

Correct positioning of the electrodes for the Edge Effect allows for equal distribution of the concentrated heating effect. Local overheating can occur in the electric field due to one-sided application of electrodes or the presence of metal objects (e.g. earrings, metal implants).

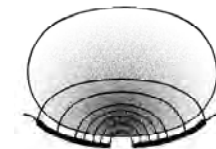

Correct

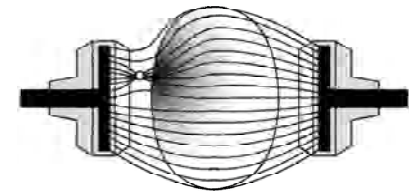

Incorrect

Positioning of Electrodes – Edge Effect and Metal Objects

TOC



OPERATION

TREATMENT TIPS (CONTINUED)

Local overheating can also occur due to electrode constrictions. This can be prevented by increasing the distance (e.g. with pillows, felt layers) of the affected body part.

Surface warming can be reduced by increasing the electrode distance. It is also possible to achieve this, however, by using different electrode sizes and varying the positions.

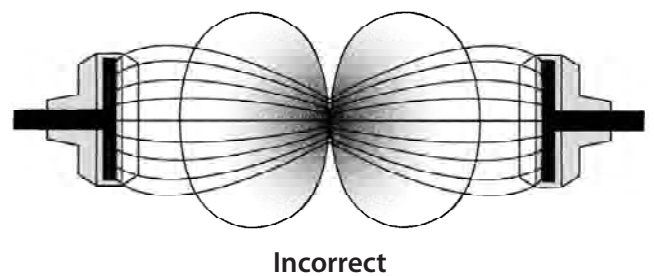
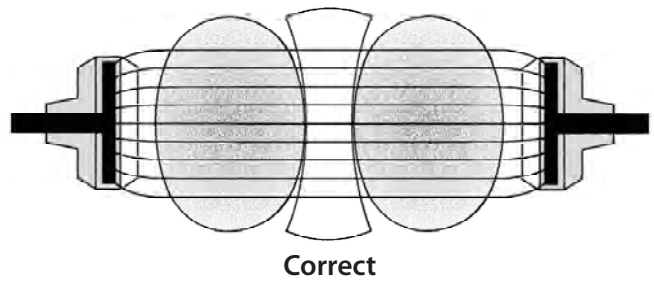

Positioning of Electrodes – Electrode Constriction



OPERATION

TREATMENT TIPS (CONTINUED)

Below you will find several examples for correct placement of electrodes:

1.

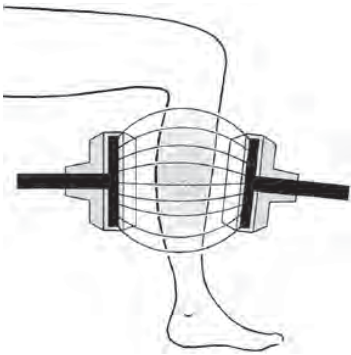

2.

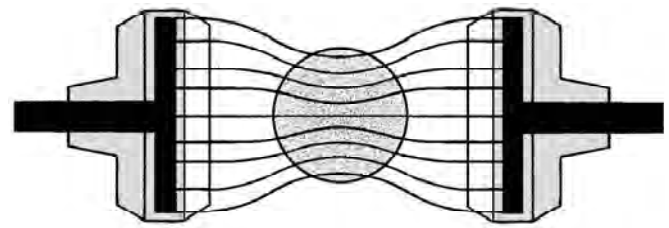

Positioning of Electrodes – Normal Cases

1. Even irradiation of extremities in the transverse field

2. Even irradiation of areas of the trunk, the head or the extremities with a large Electrode-Skin Distance



OPERATION

TREATMENT TIPS (CONTINUED)

Setting the Electrode-Skin Distance

The full power required for successful depth therapy is provided by the unit by using a large Electrode-Skin Distance (ESD).

For treatment near the surface, in which the power must be limited in accordance with the respective therapy, a small Electrode-Skin Distance is required.

The optimum setting of the capacitive electrodes can also be achieved when the electrodes are in contact with the patient's body by adjusting the electrode adjusting pin.

This adjustment changes the distance of the metal plate that is built into the electrode for determining the penetration depth of the HF field; (i.e. the distance between the metal plate and the body is increased or decreased.)

The flexible rubber electrodes adapt to the shape of the body and are held to the body with elastic bands or with small sandbags. The desired Electrode-Skin Distance can be achieved by placing a variable number of felt layers underneath.

The inductive eddy-current electrodes (monode and diplode) are generally placed in contact with the patient's body.

Set the Electrode-Skin Distance accordingly.

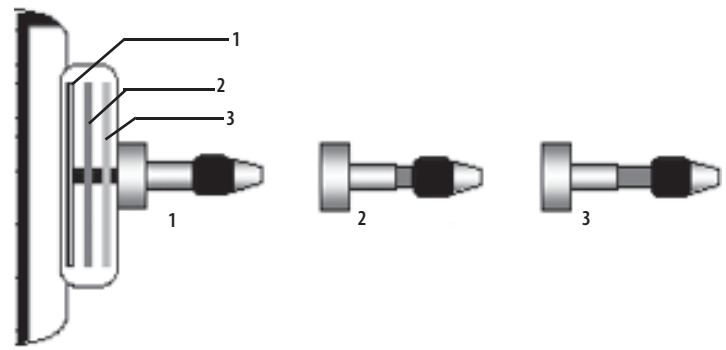

Capacitive Electrode with Adjusting Pin

Position	1	2	3
Electrode-Skin Distance	1 cm	approx. 1.75 cm	approx. 2.5 cm
Position of the adjusting pin	inserted	half pulled-out	fully pulled-out



OPERATION

TREATMENT TIPS (CONTINUED)

Dosage Levels According to Schliephake*

- Dosage I (Lowest):** No perception of heat (Athermal)
- Dosage II (Low):** Slight warming (Mild perception of heat)
- Dosage III (Medium):** Pleasant warming (Comfortable perception of heat)
- Dosage IV (Heavy):** Strong warming (strong but tolerable perception of heat)

Heat perception	Treatment Dosage			
	I	II	III	IV
None				
Low				
Medium				
Heavy				

NOTE: Always begin the treatment with a low initial dosage. After the treatment has been in progress for 1- 2 minutes, make the final setting based on the subjective response of the patient.

*Low and Reed (1990)





ERRORS

Error Codes and Descriptions

Error Code	Description
100	The patient interrupt cord was pressed. Refer to page 54 for more information about using the Patient Interrupt Cord.
102	The Save to Patient Card button was pressed, but there is no Patient Card inserted.
103	The Save to Patient Card button was pressed, but the card that is currently inserted in the Patient Data Card Port is not a valid patient data card.
104	The Save to Patient Card button was pressed, but the card that is currently inserted in the Patient Data Card Port is full.
106	No patient name was entered when the Save to Patient Card button was pressed.
107	No protocol name was entered when attempting to save a protocol.
108	The Retrieve Protocol button was pressed, but no user protocols have been set up in the unit. Refer to page 59 for more information about saving user protocols.

Error Code	Description
109	The protocol cannot be saved because the unit has maximum number of protocols already saved.
110	The MMC is being accessed, but there is no MMC inserted into the MMC port.
114	The treatment being accessed on the Patient Card is a traction type of treatment.
115	The treatment being accessed on the Patient Card is an electrotherapy type of treatment.
117	The treatment being accessed on the Patient Card is an unknown type of treatment.
119	The unit failed to tune properly. Tell the patient to be still and check all connections and electrodes.



TROUBLESHOOTING

ERRORS (CONTINUED)

WARNING

In the event that an Error message or Warning appears beginning with a 2 or 3, immediately stop all use of the unit and contact the dealer or Chattanooga Group for service. Errors and Warnings in these categories indicate an internal problem with the unit that must be tested by Chattanooga Group or a Field Service Technician certified by Chattanooga Group before any further operation or use of the system.

Use of a unit that indicates an Error or Warning in these categories may pose a risk of injury to the patient, user, or extensive internal damage to the system.

WARNING

In case of display failure or other obvious defects, switch the unit off immediately by means of the Power On/Off button and notify a certified service technician.

Using the Indicator Discharge Tube

To verify that shortwave diathermy energy is actually being transmitted, this small, fluorescent tube illuminates when it's held between the capacitive or flexible rubber electrodes, or near the monode and diplode (assuming a therapy session is in progress).

NOTE: The indicator discharge tube will not illuminate if the output power is at a low setting.

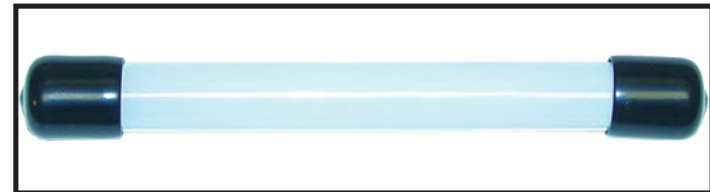



MAINTAINING THE INTELECT SHORTWAVE 100

Routine Maintenance

Keep in mind the following when maintaining the unit:

- As the manufacturer, Chattanooga Group is responsible for the safety and reliability of the unit only if it is used in accordance with this user manual.
- Safety inspections, maintenance, repairs, and modifications may be performed only by a certified service center or field technician certified by Chattanooga Group.

Cleaning and Disinfection

When cleaning the unit, keep in mind the following:

- Press the Power On/Off button so that the unit is off.
- Unplug the power plug from the power outlet before cleaning or disinfecting the unit.
- After each patient use, clean the accessories using a soft, clean cloth dampened with water and a mild antibacterial detergent. Avoid the use of abrasive materials and cleaning solvents.
- Wait until the unit is completely dry before operating it again.

 **DANGER**

- Under no circumstances may liquid penetrate the openings on the unit (e.g. the connecting sockets of the electrode cables). Therefore, do not use cleaning or disinfectant sprays.
- The unit, electrodes, and cables may not be sterilized using steam or gas.
- Never clean the unit with abrasives, disinfectants, or solvents that could scratch the housing or LCD or otherwise damage the unit.
- In order to prevent electrical shock, unplug the power plug from the power outlet before cleaning or disinfecting the unit.

Safety Inspections

The following safety inspections must be performed on this unit. This must be done by persons who, based on training, knowledge or practical experience, are capable of conducting the inspections correctly and independently.

Visual Inspection (Daily)

When performing daily inspections of the unit, pay particular attention the following areas of potential damage:

- Deformation of unit housing
- Power cable damage



MAINTENANCE

MAINTAINING THE INTELECT SHORTWAVE 100 (CONTINUED)

- Electrode connection sockets damage
- Electrode cable damage
- Capacitive Electrodes, Diplode electrode, and Monode (Drum) Electrode damage (fissures or brittle material)
- Flexible Rubber Electrodes damage (worn or thin areas or holes)

Functional Test (Daily)

When performing daily inspections of the unit, pay particular attention the following areas of potential damage:

- Correct function of indicators
- Display of operating modes
- Verify power output using the indicator discharge tube
- Patient Interrupt Cord

NOTE: It is the responsibility of the health care facility to verify that the unit complies with the facility, local, and national Earth Leakage limits.



DANGER

If the unit is not safe for operation, it must be repaired by a certified service technician and the operators must be informed of the dangers posed by the unit.



MAINTENANCE

MAINTAINING THE INTELECT SHORTWAVE 100 (CONTINUED)

Service

DANGER

Do not perform unauthorized repairs under any circumstances.

The Intellect Shortwave 100 unit must be recalibrated if it is not operating within specifications after routine maintenance and safety inspections have been performed. It is recommended that all Chattanooga Group shortwave diathermy products be returned to the factory or a certified servicing dealer for repairs or recalibration. Should the Intellect Shortwave 100 unit require service, contact the selling dealer or Chattanooga Group Service Department.

All units returned to the factory for service must include the following:

Warranty Repair/Out of Warranty Repair

1. Written statement containing the following information:
 - Return Authorization (RA) number- obtain from factory
 - Unit model number
 - Unit serial number
 - Contact person with phone and fax numbers

- Billing address (for out of warranty repair)
 - Shipping address (where to ship unit after repair)
 - Detailed description of problem or symptoms
2. Copy of original invoice issued at purchase of the unit.
 3. Ship the unit to address specified by an certified service technician.

Service to these units should be performed only by Service Technicians certified by Chattanooga Group.

NOTE: The unit was calibrated during the manufacturing process and is ready to be placed into service upon delivery.



Council Directive 2002/96/EC concerning Waste Electrical and Electronic Equipment (WEEE). Indicates a requirement not to dispose of WEEE as municipal waste. Contact your local distributor for information regarding disposal of the unit and accessories.





ACCESSORIES

STANDARD ACCESSORIES

REF.	Description	Qty
14762	Indicator Discharge Tube	1
14668	Intelect Shortwave 100 CD User Manual	1
14670	Intelect Shortwave 100 Quick Start Guide	1
020453217	Capacitive Electrode 120mm diameter	2
14712	Connection cable for capacitive electrodes	2
14779	Cable clips	2
	One of the following power cords:	
14679	US [18 AWG, 118 in (300 cm), Shielded]	1

REF.	Description	Qty
14814	Switzerland [18 AWG, 118 in (300 cm), Shielded]	1
14815	UK [18 AWG, 118 in (300 cm), Shielded]	1
14816	India [18 AWG, 118 in (300 cm), Shielded]	1
14817	Israel [18 AWG, 118 in (300 cm), Shielded]	1
14818	Denmark [18 AWG, 118 in (300 cm), Shielded]	1
14819	Australia [18 AWG, 118 in (300 cm), Shielded]	1
14820	EU [18 AWG, 118 in (300 cm), Shielded]	1
14821	Japan [18 AWG, 118 in (300 cm), Shielded]	1

NOTE: The power cord shipped with the unit will accommodate the electrical requirements for the country of use.

OPTIONAL ACCESSORIES

REF.	Description	Qty
020453218	Capacitive Electrode 165 mm diameter	1
02200002	Monode (Drum) Electrode	1
020969553	Diplode (Coil Field Electrode 18 x 39 cm) with cable	1
020453266	Flexible Rubber Electrode 180 x 120 inclusive one Linenpocket and one intermediate felt layer	1

REF.	Description	Qty
020453267	Flexible Rubber Electrode 250 x 145 inclusive one Linenpocket and one intermediate felt layer	1
10842	Rubber Strap (for use with the rubber pad electrodes)	1





WARRANTY

Chattanooga Group, a division of Encore Medical, L.P., ("Company") warrants that the Intellect Shortwave 100 ("Product") is free of defects in material and workmanship. This warranty shall remain in effect for two years (24 months) from the date of original consumer purchase. If this Product fails to function during the two year warranty period due to a defect in material or workmanship, at the Company's Option, Company or the selling dealer will repair or replace this Product without charge.

All repairs to the Product must be performed by a service center certified by the Company. Any modifications or repairs performed by unauthorized centers or groups will void this warranty. The warranty period for accessories is 180 days.

This Warranty Does Not Cover:

- Replacement parts or labor furnished by anyone other than the Company, the selling dealer or a certified Company service technician.
- Defects or damage caused by labor furnished by someone other than Company, the selling dealer or a certified Company service technician.
- Any malfunction or failure in the Product caused by product misuse, including, but not limited to, the failure to provide reasonable and necessary maintenance or any use that is inconsistent with the Product User's Manual.

COMPANY SHALL NOT BE LIABLE IN ANY EVENT FOR INCIDENTAL OR CONSEQUENTIAL DAMAGES.

Some areas do not allow the exclusion or limitation of incidental or consequential damages, so the above limitation or exclusion may not apply to you.

To Obtain Service From Company or the selling dealer under this warranty:

1. A written claim must be made within the warranty period to the Company or the selling dealer. Written claims made to the Company should be sent to:

Chattanooga Group
 4717 Adams Road
 Hixson, TN 37343
 Telephone: +1 (423) 870-7200
 FAX: +1 (423) 870-2046
 chattgroup.com
 and

2. The Product must be returned to the Company or the selling dealer by the owner.

This warranty gives you specific legal rights and you may also have other rights which vary from region to region.

The Company does not authorize any person or representative to create for it any other obligation or liability in connection with the sale of the Product. Any representation or agreement not contained in the warranty shall be void and of no effect.

THE FOREGOING WARRANTY IS IN LIEU OF ALL OTHER WARRANTIES, EXPRESSED OR IMPLIED, INCLUDING ANY WARRANTY OR MERCHANTABILITY OR FITNESS FOR A PARTICULAR PURPOSE.





APPENDIX A - EMC TABLES

TABLE 1: GUIDANCE AND MANUFACTURER’S DECLARATION–ELECTROMAGNETIC EMISSIONS

The Intelect Shortwave 100 unit is intended for use in the electromagnetic environment specified in the table below. The user of the Intelect Shortwave 100 unit should assure that it is used in such an environment.

Emission Tests	Compliance	Electromagnetic Environment - Guidance
RF emissions CISPR 11	Group 1	The Intelect Shortwave 100 uses RF energy only for its internal function. Therefore, its RF emissions are very low and are not likely to cause any interference in nearby electronic equipment
RF emissions CISPR 11	Class A	The Intelect Shortwave 100 is suitable for use in all establishments, other than domestic, and those directly connected to the public low-voltage power supply network that supplies buildings used for domestic purposes.
Harmonic emissions IEC 61000-3-2	Class A	
Voltage fluctuations/Flicker Emissions IEC 61000-3-3	Complies	





APPENDIX A - EMC TABLES

TABLE 2: GUIDANCE AND MANUFACTURER’S DECLARATION–ELECTROMAGNETIC IMMUNITY

The Intelect Shortwave 100 unit is intended for use in the electromagnetic environment specified in the table below. The user of the Intelect Shortwave 100 should assure that it is used in such an environment.

Immunity Test	IEC 60601 Test Level	Compliance Level	Electromagnetic Environment - Guidance
Electrostatic discharge (ESD) IEC 61000-4-2	±6 kV contact ±8 kV air	±6 kV contact ±8 kV air	Floors should be wood, concrete, or ceramic tile. If floors are covered with synthetic material, the relative humidity should be at least 30%.
Electrical fast transient/burst IEC 61000-4-4	±2 kV for power supply lines ±1 kV for input/output lines	±2 kV for power supply lines N/A - No Input/Output lines	Mains power quality should be that of a typical commercial or hospital environment.
Surge IEC 61000-4-5	±1 kV differential mode ±2 kV common mode	±1 kV differential mode ±2 kV common mode	Mains power quality should be that of a typical commercial or hospital environment.
Voltage dips, short interruptions and voltage variations on power supply input lines IEC 61000-4-11	<5% U_i (>95% dip in U_i) for 0.5 cycle 40% U_i (60% dip in U_i) for 5 cycles 70% U_i (30% dip in U_i) for 25 cycles <5% U_i (>95% dip in U_i) for 5 sec	<5% U_i (>95% dip in U_i) for 0.5 cycle 40% U_i (60% dip in U_i) for 5 cycles 70% U_i (30% dip in U_i) for 25 cycles <5% U_i (>95% dip in U_i) for 5 sec	Mains power quality should be that of a typical commercial or hospital environment. If the user of the Intelect Shortwave 100 requires continued operation during power mains interruptions, it is recommended that the Intelect Shortwave 100 be powered from an uninterrupted power supply or a battery.
Power frequency (50/60Hz) magnetic field IEC 61000-4-8	3 A/m	3 A/m	Power frequency magnetic fields should be at levels characteristic of a typical location in a typical commercial or hospital environment.

NOTE: U_i is the a.c. mains voltage prior to application of the test level.





APPENDIX A - EMC TABLES

TABLE 2: GUIDANCE AND MANUFACTURER’S DECLARATION–ELECTROMAGNETIC IMMUNITY (CONTINUED)

The Intellect Shortwave 100 unit is intended for use in the electromagnetic environment specified in the table below. The user of the Intellect Shortwave 100 unit should assure that it is used in such an environment.

Immunity Test	IEC 60601 Test Level	Compliance Level	Electromagnetic Environment - Guidance
			Portable and mobile RF communications equipment should be used no closer to any part of the Intellect Shortwave 100, including cables, than the recommended separation distance calculated from the equation applicable to the frequency of the transmitter.
			Recommended separation distance:
Conducted RF IEC 61000-4-6	3 Vrms 150 kHz to 80 MHz	3 Vrms	$d = \frac{[3.5]\sqrt{P}}{V_1}$
Radiated RF IEC 61000-4-3	3 V/m 80 MHz to 2.5 GHz	3 V/m	$d = \frac{[3.5]\sqrt{P}}{E_1}$ 80 MHz to 800 MHz $d = \frac{[7]\sqrt{P}}{E_1}$ 800 MHz to 2.5 GHz
			<p>where P is the maximum output power rating of the transmitter in watts (W) according to the transmitter manufacturer and d is the recommended separation distance in meters (m).</p> <p>Field strengths from fixed RF transmitters, as determined by an electromagnetic site survey^a, should be less than the compliance level in each frequency range^b.</p> <p>Interference may occur in the vicinity of equipment marked with the following symbol: </p>

NOTE 1: At 80 MHz and 800 MHz, the higher frequency range applies.

NOTE 2: These guidelines may not apply in all situations. Electromagnetic propagation is affected by absorption and reflection from structures, objects, and people.

^a Field strengths from fixed transmitters, such as base stations for radio (cellular/cordless) telephones and land mobile radios, amateur radio, AM and FM radio broadcast and TV broadcast cannot be predicted theoretically with accuracy. To assess the electromagnetic environment due to fixed RF transmitters, an electromagnetic site survey should be considered. If the measured field strength in the location in which the Intellect Shortwave 100 is used exceeds the applicable RF compliance level above, the Intellect Shortwave 100 should be observed to verify normal operation. If abnormal performance is observed, additional measures may be necessary, such as reorienting or relocating the Intellect Shortwave 100.

^b Over the frequency range 150 kHz to 80 MHz, field strengths should be less than 3 V/m.





APPENDIX A - EMC TABLES

TABLE 3: RECOMMENDED SEPARATION DISTANCES BETWEEN PORTABLE AND MOBILE RF COMMUNICATIONS EQUIPMENT AND THE INTELECT SHORTWAVE 100

The Intelect Shortwave 100 unit is intended for use in an electromagnetic environment in which radiated RF disturbances are controlled. The customer or the user of the Intelect Shortwave 100 can help prevent electromagnetic interference by maintaining a minimum distance between portable and mobile RF communications equipment (transmitters) and the Intelect Shortwave 100 as recommended below, according to the maximum output power of the communications equipment.

Rated Maximum Output Power of Transmitter W	Separation Distance According to Frequency of Transmitter m		
	150 kHz to 80 MHz	80 MHz to 800 MHz	800 MHz to 2.5 GHz
	$d = \frac{[3.5]\sqrt{P}}{V_1}$	$d = \frac{[3.5]\sqrt{P}}{E_1}$	$d = \frac{[3]\sqrt{P}}{E_1}$
0.01	0.12	0.12	0.23
0.1	0.38	0.38	0.73
1	1.2	1.2	2.3
10	3.8	3.8	7.3
100	12	12	23

For transmitters rated at a maximum output power not listed above, the recommended separation distance d in meters (m) can be estimated using the equation applicable to the frequency of the transmitter, where P is the maximum output power rating of the transmitter in watts (W) according to the transmitter manufacturer.

- NOTE 1:** At 80 MHz and 800 MHz, the separation distance for the higher frequency range applies.
- NOTE 2:** These guidelines may not apply in all situations. Electromagnetic propagation is affected by absorption and reflection from structures, objects, and people.





TOC



Medical Device Safety Service (MDSS)

GmbH

Schiffgraben 41

30175 Hannover, Germany

Telephone: + 49 -511-6262-8630

Fax: + 49-511-6262-8633

Chattanooga Group

4717 Adams Road

P.O. Box 489

Hixson, TN 37343 U.S.A.

+1-423-870-7200 OUTSIDE U.S.A.

+1 423-870-2046 OUTSIDE U.S.A. FAX

chattgroup.com



0413

14666B

Chattanooga Group is an ISO 13485 Certified Company

© 2009 Encore Medical, L.P.